



Installation and Operation Guide



Manual #69-4333-004 of Assembly #60-4334-005
Copyright © 2012. All rights reserved, Teledyne Isco
Revision A, June 15, 2012

Foreword

This instruction manual is designed to help you gain a thorough understanding of the operation of the equipment. Teledyne Isco recommends that you read this manual completely before placing the equipment in service.

Although Teledyne Isco designs reliability into all equipment, there is always the possibility of a malfunction. This manual may help in diagnosing and repairing the malfunction.

If the problem persists, call or e-mail the Teledyne Isco Technical Service Department for assistance. Simple difficulties can often be diagnosed over the phone.

If it is necessary to return the equipment to the factory for service, please follow the shipping instructions provided by the Customer Service Department, including the use of the **Return Authorization Number** specified. **Be sure to include a note describing the malfunction.** This will aid in the prompt repair and return of the equipment.

Teledyne Isco welcomes suggestions that would improve the information presented in this manual or enhance the operation of the equipment itself.

Teledyne Isco is continually improving its products and reserves the right to change product specifications, replacement parts, schematics, and instructions without notice.

Contact Information

Customer Service

Phone: (800) 228-4373 (USA, Canada, Mexico)
(402) 464-0231 (Outside North America)
Fax: (402) 465-3022
Email: IscoCSR@teledyne.com

Technical Support

Phone: (800) 775-2965 (Analytical)
(866) 298-6174 (Samplers and Flow Meters)
Email: IscoService@teledyne.com

Return equipment to: 4700 Superior Street, Lincoln, NE 68504-1398

Other Correspondence

Mail to: P.O. Box 82531, Lincoln, NE 68501-2531
Email: IscoInfo@teledyne.com
Web site: www.isco.com

General Warnings

Before installing, operating, or maintaining this equipment, it is imperative that all hazards and preventive measures are fully understood. While specific hazards may vary according to location and application, take heed of the following general warnings:

 **WARNING**

Avoid hazardous practices! If you use this instrument in any way not specified in this manual, the protection provided by the instrument may be impaired.

 **AVERTISSEMENT**

Éviter les usages périlleux! Si vous utilisez cet instrument d'une manière autre que celles qui sont spécifiées dans ce manuel, la protection fournie de l'instrument peut être affaiblie; cela augmentera votre risque de blessure.

Hazard Severity Levels

This manual applies *Hazard Severity Levels* to the safety alerts. These three levels are described in the sample alerts below.

 **CAUTION**

Cautions identify a potential hazard, which if not avoided, may result in minor or moderate injury. This category can also warn you of unsafe practices, or conditions that may cause property damage.

 **WARNING**









Warnings identify a potentially hazardous condition, which if not avoided, could result in death or serious injury.

 **DANGER**

DANGER – limited to the most extreme situations to identify an imminent hazard, which if not avoided, will result in death or serious injury.

Hazard Symbols

The equipment and this manual use symbols used to warn of hazards. The symbols are explained below.

Hazard Symbols	
Warnings and Cautions	
	The exclamation point within the triangle is a warning sign alerting you of important instructions in the instrument's technical reference manual.
	The lightning flash and arrowhead within the triangle is a warning sign alerting you of "dangerous voltage" inside the product.
Symboles de sécurité	
	Ce symbole signale l'existence d'instructions importantes relatives au produit dans ce manuel.
	Ce symbole signale la présence d'un danger d'électocution.
Warnungen und Vorsichtshinweise	
	Das Ausrufezeichen in Dreieck ist ein Warnzeichen, das Sie darauf aufmerksam macht, daß wichtige Anleitungen zu diesem Handbuch gehören.
	Der gepfeilte Blitz im Dreieck ist ein Warnzeichen, das Sie vor "gefährlichen Spannungen" im Inneren des Produkts warnt.
Advertencias y Precauciones	
	Esta señal le advierte sobre la importancia de las instrucciones del manual que acompañan a este producto.
	Esta señal alerta sobre la presencia de alto voltaje en el interior del producto.

Signature™ Flow Meter

Table of Contents

Section 1 Introduction

1.1 Quick Start	1-2
1.2 Data Integrity	1-3
1.3 Security	1-3
1.4 Compatible Equipment	1-3
1.5 Identifying Signature Components	1-5
1.6 Controls and Indicators	1-6
1.6.1 Keypad	1-6
1.6.2 Display and LED	1-7
1.6.3 Display Contrast	1-7
1.7 Technical Specifications	1-7

Section 2 Setup and Programming

2.1 User Interface	2-1
2.1.1 Keypad Functions	2-1
2.1.2 Connecting to the Signature with Flowlink	2-2
2.2 The Home Screen	2-7
2.3 Shortcuts	2-7
2.3.1 Level Adjustment	2-7
2.3.2 Histogram	2-7
2.3.3 Report View	2-7
2.4 Programming	2-8
2.4.1 Off-Screen Content	2-8
2.4.2 Character Grid	2-8
2.4.3 Pull Down Menus	2-9
2.5 Program Steps (Menu Trees)	2-9
2.6 Hardware Setup	2-10
2.6.1 Smart Sensor Setup (TIENet)	2-11
2.6.2 SDI-12 Setup	2-12
2.6.3 Modbus Input Setup	2-13
2.6.4 Modbus Output Setup	2-16
2.6.5 Modem Setup	2-16
2.7 Configure	2-17
2.7.1 Site Setup	2-18
2.7.2 Measurement Setup	2-18
2.7.3 Adjust	2-20
2.7.4 Equation/Trigger Setup	2-21
2.7.5 Data Storage/Push Setup	2-22
2.7.6 Sampler Setup	2-23
2.7.7 Outputs/Alarms Setup	2-23
2.7.8 Reset Totalizers	2-26
2.7.9 Reports/History Setup	2-26
2.8 Administration	2-27
2.8.1 Language Options	2-28
2.8.2 Set New Passcode	2-28
2.8.3 Update Firmware	2-28

2.8.4	Sensor Diagnostics	2-28
2.8.5	Display Signature Information	2-28
2.8.6	Display License Information	2-28
2.8.7	Gather Fault Data	2-28
2.8.8	Restore to Factory Defaults	2-28
2.9	Home	2-29
2.10	USB Options	2-29
2.10.1	Retrieve Text Reports	2-30
2.10.2	Retrieve Data	2-30
2.10.3	Update Firmware	2-30
2.10.4	Save Current Program	2-31
2.10.5	Load Existing Program	2-31
2.10.6	Save Signature Information	2-31
2.10.7	Gather Fault Data	2-31
2.10.8	None of the above	2-31
2.11	Signature Data in Flowlink	2-31
2.11.1	Event Viewer	2-31
2.11.2	Verifying Exported Reports	2-32

Section 3 Installation

3.1	Accessing the Interior	3-1
3.2	Case Bottom Cable Entries	3-3
3.2.1	Cable Fittings	3-5
3.3	Connecting TIENet Devices	3-7
3.4	Power	3-10
3.4.1	Connecting Mains Power	3-10
3.5	Mounting the Signature	3-11
3.6	Outdoor Recommendations	3-12
3.7	The Bubble Line	3-15
3.7.1	Standard Bubble Lines	3-15
3.7.2	Comparing Vinyl and PTFE Bubble Lines	3-15
3.7.3	Bubble Line Length	3-15
3.7.4	Attaching the PTFE Bubble Line	3-16
3.7.5	Attaching the Vinyl Bubble Line	3-16
3.7.6	Installing the Bubble Line	3-16
3.7.7	High-Velocity Flow Streams	3-17
3.7.8	Stilling Wells	3-18
3.7.9	Flume Bubble Line Fittings	3-18
3.7.10	Bubble Line Extensions	3-18
3.7.11	Open Channel Installation	3-19
3.8	Level Calibration	3-20

Section 4 Equipment Options

4.1	AC Power Cord Kit	4-2
4.2	Battery Backup	4-4
4.3	Mechanical Totalizer	4-6
4.4	TIENet™ Devices	4-10
4.4.1	Ultrasonic Level Sensor	4-10
4.4.2	Bubbler Level Sensor	4-10
4.4.3	Sampler Interface	4-10
4.4.4	pH and Temperature Device	4-10
4.4.5	TIENet Expansion Box	4-11
4.4.6	Analog Current Output	4-12
4.5	Reference Port Tubing Kit	4-16
4.6	Isco Flowlink Software	4-18
4.7	Ethernet Modem	4-18

4.7.1 Ethernet Modem Configuration	4-21
4.7.2 Network Firewall Settings	4-22
4.8 Cellular Modems	4-23
4.8.1 CDMA Modem	4-23
4.8.2 GSM Modem	4-24
4.8.3 Installing the Cellular Modem	4-24
4.8.4 Cellular Modem Configuration	4-26

Section 5 Maintenance and Servicing

5.1 Cleaning	5-1
5.2 Firmware Updates	5-1
5.3 Desiccant	5-2
5.3.1 Internal Desiccator	5-3
5.3.2 External Desiccator	5-3
5.4 Troubleshooting	5-5
5.4.1 Signature Flow Meter	5-6
5.4.2 TIENet 300 Connector Case	5-8
5.4.3 TIENet 301 pH/Temp	5-8
5.4.4 TIENet 306 Sampler Interface	5-9
5.4.5 TIENet 308 Analog Output	5-9
5.4.6 TIENet 310 USLS	5-10
5.4.7 TIENet 330 Bubbler	5-11
5.5 330 Bubbler Installation	5-12
5.6 Front Cover Replacement	5-16
5.7 System Reset	5-16
5.8 Service and Repair	5-17

Appendix A Replacement Parts

A.1 How to Order	A-1
A.2 Signature Flow Meter	A-2
A.3 330 Bubbler	A-12

Appendix B Options and Accessories

B.1 Ordering Information	B-1
B.2 Signature Flow Meter Accessories	B-1
B.3 TIENet Devices and Accessories	B-2
B.4 Modems	B-3
B.5 Sensor Mounting Rings	B-3
B.5.1 Spring Rings	B-3
B.5.2 Scissor Rings	B-3
B.6 Manuals	B-3

Appendix C Material Safety Data Sheets

List of Figures

1-1 Signature Flow Meter	1-1
1-2 Multiple options can be used in any combination	1-4
1-3 Front and exterior component identification	1-5
1-4 Home screen and basic keypad functions	1-6
2-1 Flowlink Connect screen	2-3
2-2 Site Info tab	2-4
2-3 Devices tab	2-5

2-4	Program tab: Accessing the browser	2-6
2-5	Home screen (normal operating mode)	2-7
2-6	Character grid	2-8
2-7	Menu Tree: Top menu	2-9
2-8	Menu Tree: Hardware Setup	2-10
2-9	Measurement parameters for each TIENet device	2-12
2-10	Modbus Input Setup	2-14
2-11	Editing Modbus device parameters	2-15
2-12	Modbus Output Setup	2-16
2-13	Menu Tree: Configure	2-17
2-14	Menu Tree: Flow measurement setup	2-19
2-15	Menu Tree: Volume Input Setup (total flow)	2-20
2-16	Defining conditions & building equations.	2-22
2-17	Local alarm setup	2-24
2-18	SMS and Server alarm setup (modem required)	2-25
2-19	Menu Tree: Administration	2-27
2-20	Menu Tree: USB Options	2-29
2-21	Event Viewer in Flowlink	2-32
2-22	Report file verifier	2-33
3-1	Open door and front panel to access interior	3-2
3-2	Connector case, connectors, and fuses	3-2
3-3	Connector Case cable entries for power and external devices	3-4
3-4	Strain relief ³ / ₄ NPT Cord-grip fitting for TIENet devices	3-5
3-5	Cord-grip fittings installed	3-5
3-6	Diameter-seal plugs for unused ports	3-6
3-7	TIENet Device terminal strips	3-7
3-8	Installing TIENet cable with a cord-grip fitting	3-7
3-9	TIENet Device terminal connections	3-8
3-10	Attach wired terminal strip to connector case socket	3-9
3-11	Position and secure the cable	3-9
3-12	Location of power supply	3-10
3-13	Signature Flow Meter mounted on wall	3-11
3-14	Panel shield - recommended for outdoor installations	3-12
3-15	Specification drawing: Signature Bubbler Flow Meter, 1 of 2	3-14
3-16	Specification drawing: Signature Bubbler Flow Meter, 2 of 2	3-14
3-17	Positioning the Bubble Line in the Flow Stream	3-17
3-18	Installing the Stainless Steel Bubble Line Extension	3-19
3-19	Level adjustment and calibration	3-20
4-1	Installing AC line cord with a cord-grip fitting	4-2
4-2	Access terminals and connect line cord	4-3
4-3	Re-seating the power supply	4-3
4-4	Battery backup kit contents	4-4
4-5	Attach extension cable to the connector case	4-5
4-6	Installing the battery backup mounting plate	4-5
4-7	Backup battery, installed	4-6
4-8	Disconnect and remove bubbler module	4-7
4-9	Remove totalizer window cover	4-8
4-10	Optional non-resettable totalizer installation	4-9
4-11	TIENet Expansion box	4-11
4-12	Analog output channel identification and terminal connections	4-12
4-13	TIENet 308 Analog output card installed (two shown)	4-13
4-14	308 Device configuration	4-14
4-15	Analog output setup	4-15
4-16	Reference port kit (full length not shown)	4-16
4-17	Reference port kit: Remove filter and barb	4-16
4-18	Reference port kit: Install filter and barb	4-17
4-19	Reference port kit: Installed on flow meter	4-17
4-20	Ethernet modem kit contents	4-19
4-21	Ethernet modem installation	4-20

4-22 Ethernet modem setup: Communication settings (default settings shown) . . .	4-21
4-23 Locating the NODE ID (MAC address) on the ethernet modem	4-22
4-24 Magnetic-mount cellular antenna	4-23
4-25 CDMA Cellular modem	4-23
4-26 GSM Cellular modem	4-24
4-27 Cellular modem kit contents	4-24
4-28 Cellular modem installation	4-25
4-29 Cellular modem setup: Communication settings	4-26
5-1 Locating firmware updates	5-1
5-2 USB Micro adaptor cable (flash drive not included)	5-2
5-3 Removing the internal desiccant bag	5-3
5-4 External desiccator, installed	5-3
5-5 Desiccant indicating saturation	5-4
5-6 Removing the external desiccant cartridge	5-4
5-7 Opening the desiccant cartridge chambers	5-5
5-8 Remove non-bubbler shield	5-12
5-9 Remove bubbler module	5-13
5-10 330 Bubbler assembly installation	5-14
5-11 Routing and connections of 330 bubbler tubing	5-15
5-12 Front cover (door) replacement	5-16

List of Tables

1-1 Signature Flow Meter Technical Specifications	1-7
1-2 TIENet 330 Bubbler Module Technical Specifications	1-8
2-1 Example Modbus Input Settings	2-13
5-1 Troubleshooting: Signature Flow Meter	5-6
5-2 Troubleshooting: TIENet 300 Connector Case	5-8
5-3 Troubleshooting: TIENet 301 pH/Temperature Device	5-8
5-4 Troubleshooting: TIENet 306 Sampler Interface	5-9
5-5 Troubleshooting: TIENet 308 4-20mA Analog Output	5-9
5-6 Troubleshooting: TIENet 310 Ultrasonic Level Sensor	5-10
5-7 Troubleshooting: TIENet 330 Bubbler Module	5-11

Signature™ Flow Meter

Section 1 Introduction

The Signature Flow Meter is designed for open channel flow monitoring applications using any combination of flow and parameter measurement technologies and sampling, depending on what is required at the measurement site.

The bubble line is anchored in the flow stream at the appropriate measuring point in the weir, flume, or other open channel flow situation. Air slowly bubbles out of the line into the flow stream. The pressure in the bubble line is proportional to the liquid level in the flow stream, and the flow meter measures this pressure, sensing the liquid level.

The Signature has built-in standard level-to-flow conversions that cover the majority of open channel flow measurement situations. Flow measurement is usually a calculation based on a known relationship between liquid level and flow rate. The Signature can calculate flow using standard open channel level-to-flow conversions, as well as equations, or data points, depending upon the measurement device(s) attached to the meter and the program specified by the user.

Included with the Signature meter is a laminated **Quick Start Guide**, reproduced on the following page. Attach the quick start guide somewhere close to where the Signature meter is mounted for quick reference.



Figure 1-1 Signature Flow Meter

1.1 Quick Start

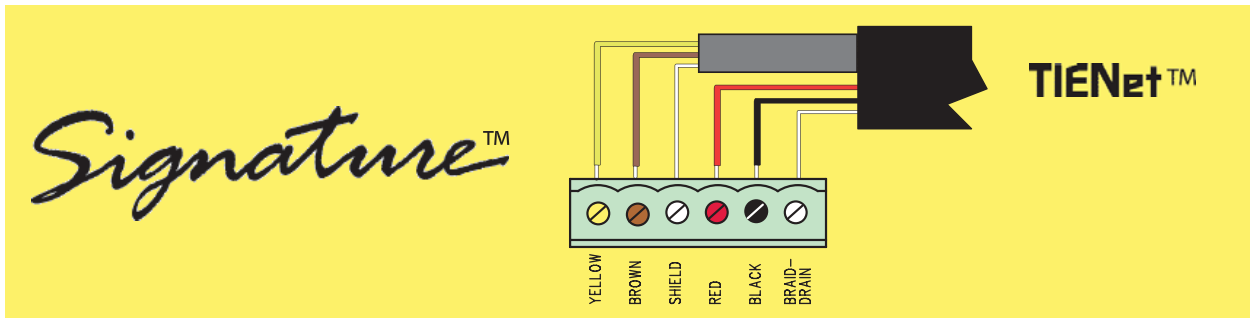

Numerical: **0**, **1**, **2** . . .

- Enter values • Type characters

Arrows: ,  . . .

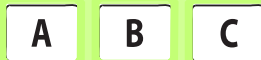

- Navigate up, down, left, right

Soft Keys:



- Current displayed function
- **Back** = Return to last menu
- **Next** = Confirm & advance to next step

Enter: 

- Open list • Confirm selection • Activate field
-  = Pull down list available
-  = Character grid available

Delete / Exit: 

- Clear last entry • Exit list • Close window

Home: 

- Return to Home Screen from anywhere

Hardware Setup

TIENet Devices

SDI-12 Setup

Modbus In

Modbus Out

Modem

Configure

Site: Clock, Name, Display, Units

Measurement Setup:
Level, Flow, Volume

Adjust: Level, pH

Equation / Trigger

Data Storage Rate / Data Push

Sampler Interface Setup

Outputs: Alarm, Analog

Reset Totalizers

Reports / History

Administration

Language

Set New Passcode

Update Firmware

Sensor Diagnostics

System Information

License Information

Gather Fault Data

Restore Defaults

1.2 Data Integrity

What makes the Signature Flow Meter unique is its ability to verify data integrity. This is accomplished by logging four special event data types that cannot be altered, and are designed to alert the user to any trends or anomalies, and to assess compliance. This data can be downloaded from the flow meter and observed in tabular or graphical format alongside regular site data, using Flowlink software (see Section 2.11 *Signature Data in Flowlink*).

The data can also be downloaded onto a flash drive via the USB port on the front panel of the flow meter, and imported into a spreadsheet or other viewing application (refer to Section 2.10 *USB Options* for more information).

The four event data types are:

Program Report – Tracks changes to the Signature Meter’s configuration

Summary Report – Documents summaries of data measurements (e.g. Min/Max/Avg)

Diagnostic Report – Tracks results from diagnostic tests

History Report – Tracks user and meter events (i.e., level adjustments, calibration, data push, etc.)

1.3 Security

The Signature Flow Meter can be secured shut with a padlock with the hasp on the right side of the housing (refer to Figure 1-3). The program settings and recorded data can be protected by a user-selected passcode (refer to Section 2.8.2 *Set New Passcode*).

1.4 Compatible Equipment

The Signature Flow Meter can interface with a variety of measurement devices and other system components, depending on site requirements.

Measurement devices for flow and water quality can be connected to the same Signature and run simultaneously with TIENet™ connectivity (up to 9 TIENet devices). The flow meter can also communicate with an optional Teledyne Isco wastewater sampler.

For descriptions of interfacing and parameter sensing TIENet devices, refer to Section 4 *Equipment Options*. Each external TIENet device comes with its own user manual.

The Signature is capable of receiving data from devices using Modbus ASCII or Modbus RTU protocol.

A variety of application-specific accessories are available from Teledyne Isco. Refer to Appendix B *Options and Accessories* for a complete list with ordering information.

A basic Signature system has one or more TIENet devices for flow and/or parameter measurement connected to the Signature Flow Meter (up to nine possible TIENet devices at once). Other

configurations may include an enclosure and additional internal or external devices, including analog output cards, a modem, up to two SDI-12 inputs, and Modbus devices.

When connected remotely via modem, the Signature Flow Meter's own browser provides remote control and data access.

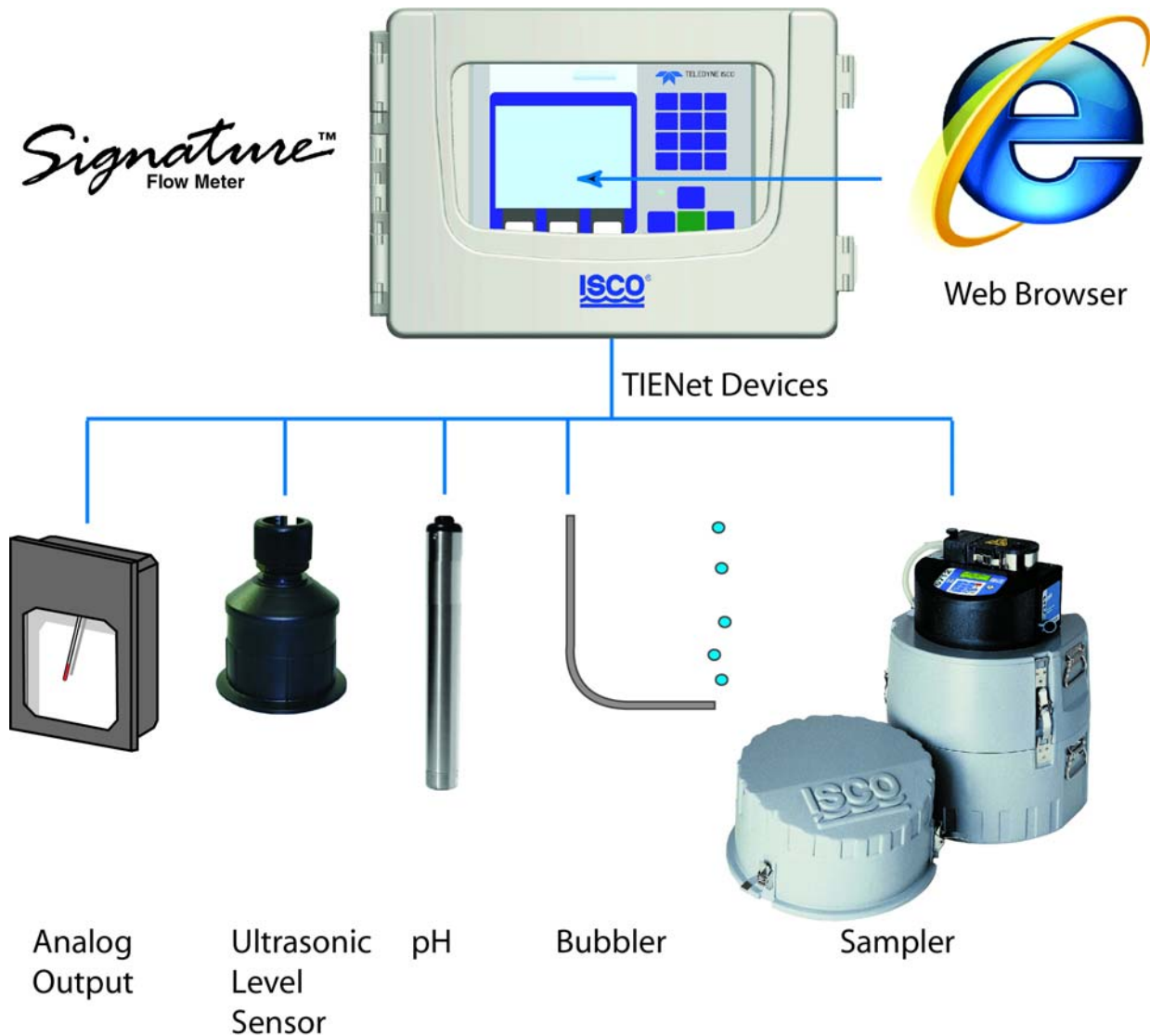

Figure 1-2 Multiple options can be used in any combination

1.5 Identifying Signature Components

Figure 1-3 identifies key components of the Signature Flow Meter.

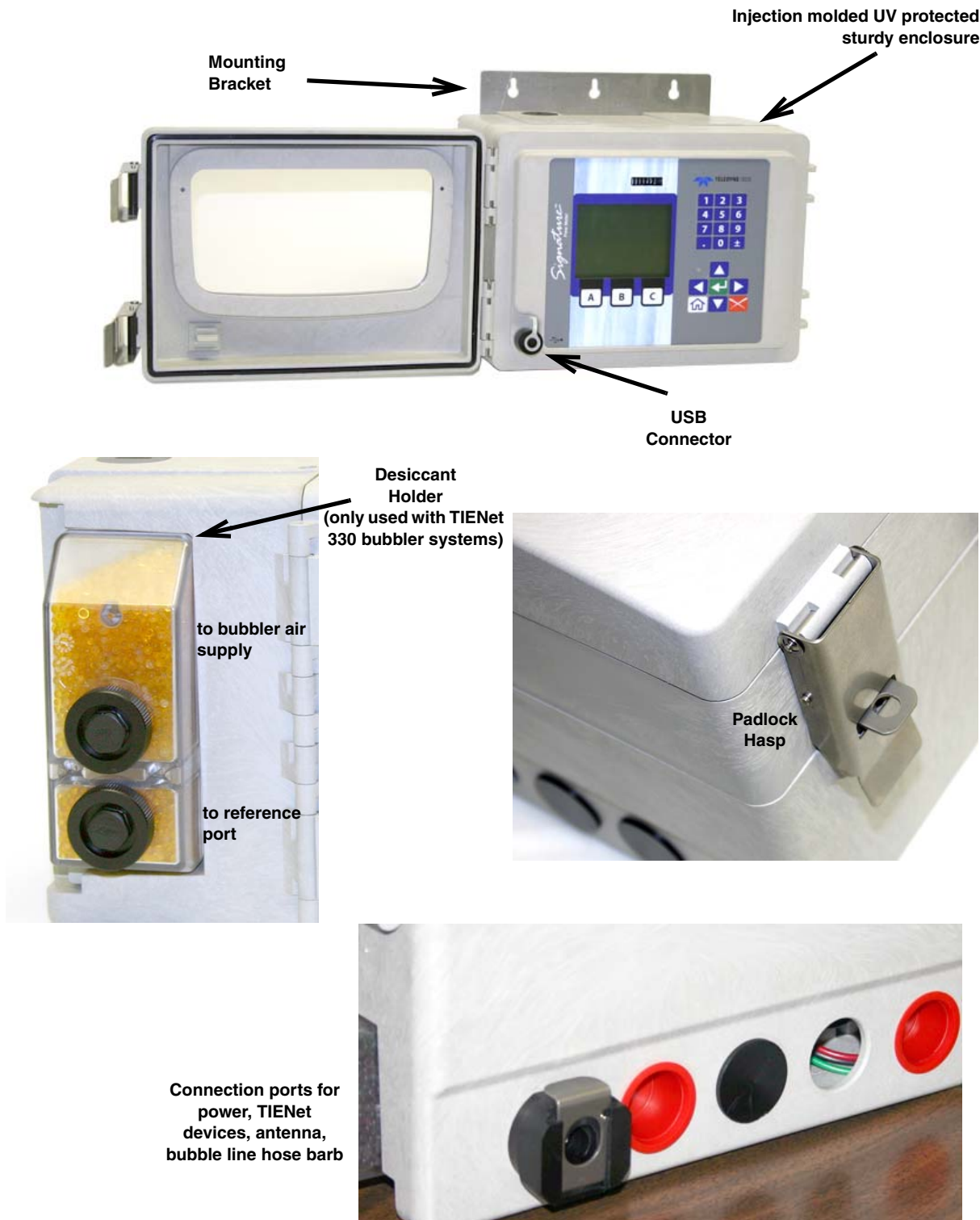

Figure 1-3 Front and exterior component identification

1.6 Controls and Indicators

Before programming and operating the Signature Flow Meter, become familiar with the keypad and standard screens.

1.6.1 Keypad

Keys are identified with summary in Figure 1-4; keypad functions are detailed in Section 2.1.1.

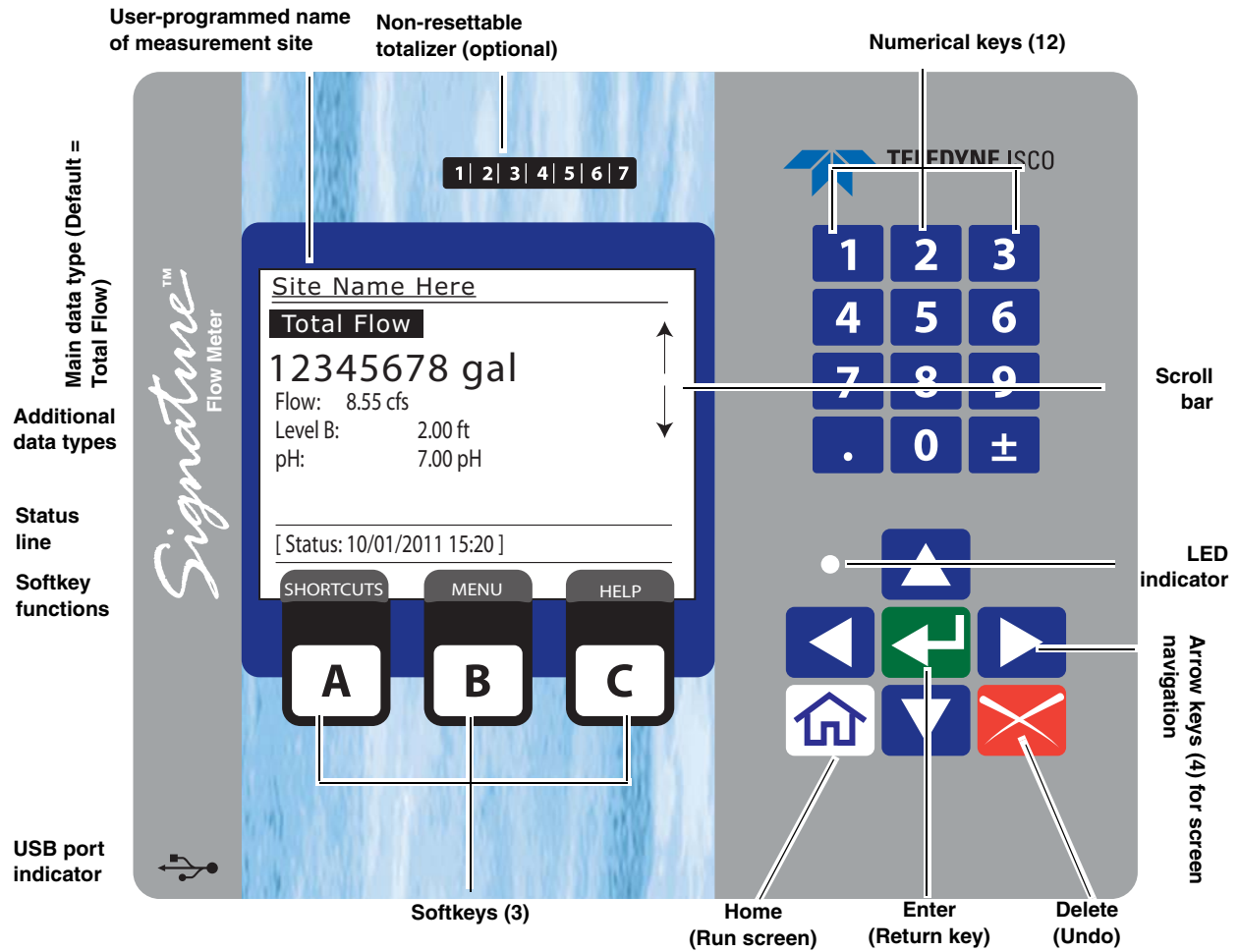

Figure 1-4 Home screen and basic keypad functions

Below the display are three software configured function keys (softkeys) that are used to make selections and navigate through menus. Their specific functions are dependent upon what operation you are performing, and will appear in the display window.

1.6.2 Display and LED



The LED on the front panel is aligned next to the Status line on the display screen. A green light indicates that new information is available for viewing in the Status line. A red light indicates a warning or a user-defined alarm condition, with further details viewable by pressing the Alarm softkey (C).

Figure 1-4 shows the standard home screen, or run screen.

Displayed menus and programming steps are explained in Section 2 *Setup and Programming*.

1.6.3 Display Contrast

The contrast of the LCD screen can be adjusted using the keypad.

To adjust the contrast, hold down the ± key  and repeatedly press the down arrow  (softer) or the up arrow  (sharper) to achieve the desired appearance.

1.7 Technical Specifications

Table 1-1 provides technical specifications for the Signature Flow Meter. Table 1-2 provides technical specifications for the TIENet 330 bubbler module.

Table 1-1 Signature Flow Meter Technical Specifications	
Size (HxWxD)	22.6 x 31.0 x 20.9 cm (8.9 x 12.2 x 8.2 in) with mounting bracket & external desiccator
Weight	
Flow Meter, No Bubbler	Signature w/o options: 4.5 kg (10 lbs) Signature w/ all interior options: 4.9 kg (10.7 lbs) Signature w/ all int. options + mounted battery backup: 7.8 kg (17.3 lbs)
Bubbler Flow Meter	Signature w/o options: 5.9 kg (13 lbs) Signature w/ all interior options: 6.1 kg (13.5 lbs) Signature w/ all int. options + mounted battery backup: 9.1 kg (20 lbs)
Materials	
Housing	PPO Plastic (Noryl)
Window	Polycarbonate
Hardware	Stainless Steel
Enclosure	NEMA4X/IP66
Power	100 to 240 VAC, 50/60Hz, 1.3A; Disconnect Device = Line Cord 12VDC (optional battery backup)
Connections to Signature Flow Meter	
External TIENet devices	Bottom Cable entry, 1 to 4 position (³ / ₄ " NPT user-supplied conduit or optional cord grips); Pluggable screw terminals, 6-position;
Power supply	Screw terminal, Wire 14-22 AWG
Parameter inputs	Fixed terminals, 3-pin, Wire 14-30 AWG
Analog output card(s)	Pluggable screw terminal, 3-position, Wire 16-26 AWG
Cellular Modems	Antenna Custom SMB connector
Ethernet	RJ-45 connector
330 Bubbler module	Internal, factory-installed

Table 1-1 Signature Flow Meter Technical Specifications (Continued)

Flow Measurement Technologies	Ultrasonic (TIENet 310) Bubbler (TIENet 330)
Flow Conversions	Weir, Flume, British Flume, Metering Insert, Manning Formula, Equation, LTF Data Points (up to 50 pairs)
Data Storage	Non-volatile flash; retains stored data during program updates. Interval: 15 or 30 seconds; 1,2, 5,15, or 30 minutes; or 1, 2, 4, 12, or 24 hrs Capacity: 512 Kbytes (180 days with 5 parameters logged at 1 minute intervals, reports at 24-hour intervals)
Setup and Data Retrieval	Serial connection to PC via USB; Cellular or Ethernet modem
Ambient Temperature Range (Operation and Storage)	-20 to 60 °C (-4 to 140 °F) NOTE — The operating ambient temperature range of the optional mechanical totalizer (see Section 4.3) is -10 to 60 °C (14 to 140 °F). NOTE — The operating ambient temperature range of the optional ethernet modem (see Section 4.7) is -20 to 40 °C (-4 to 104 °F).
Optional Teledyne Isco Sampler Interfacing	TIENet 306 device Output: Flow pacing, Enabling on trigger Input: Event and bottle information
Optional 308 TIENet analog output: Range Isolation Maximum Load Outputs per card	4 to 20 mA Monolithic air core transformer technology 500Ω 2
Industry Standard Inputs	Two SDI-12, RS485 Modbus ASCII & RTU
Industry Standard Outputs	4-20 mA Analog, Modbus ASCII & RTU
Communication Options	Direct USB Serial Connection, CDMA (1XRTT), GSM (GPRS), and Ethernet

Table 1-2 TIENet 330 Bubbler Module Technical Specifications

Operation and Storage Temperature	-20 to 60 °C (-4 to 140 °F)
Level Measurement Range	0.003 to 3.05m (0.01 to 10 ft.)
Measurement Accuracy	±0.002m @ 22°C (±0.007 @ 72°F)
Temperature Compensation Range	0 to 60°C (32 to 140°F)
Temperature Coefficient (within compensated range)	±0.0003 x Level (m) x Temperature deviation from 22 °C ±0.00017 x Level (ft) x Temperature deviation from 72 °F
Bubble Line Entry	1/8" Hose barb through bottom cable entry

Signature™ Flow Meter

Section 2 Setup and Programming

The Signature Flow Meter is shipped from the factory with a default program already installed. Your particular installation will normally require different program settings, specific to your monitoring site and application.

This section of the manual explains the Signature's operating modes, and provides instructions for site setup and programming. Programming may be performed before transportation to the installation site.

2.1 User Interface

The Signature Flow Meter can be set up, programmed, and interrogated directly through the keypad and display screen, or remotely using a computer equipped with Teledyne Isco's Flowlink® software, with either a USB cable or optional modem.

The Signature Flow Meter has its own browser, accessed via Flowlink, that mirrors the physical keypad and display.

2.1.1 Keypad Functions

The following briefly explains the basic function of each key.

 The numerical keys are for entering values during setup/programming.

 The large softkeys (A, B, and C) perform whatever function is currently displayed above them. Note that pressing the BACK softkey (A) will discard any changes you have made without saving.

 The arrow keys are for navigating to different areas on- and off-screen. The up/down arrows navigate a single line at a time.

 From the home screen, the Enter key is used to adjust or configure the currently highlighted parameter.

From programming screens, the Enter key confirms selections and entries you have made, opens the setup/programming screen for a highlighted parameter, displays the character grid for alphanumeric entry, displays a calendar for date selection, or displays the pull down menu for a highlighted field.

 **Note**
Enter is for selection only. The NEXT softkey is for selection and advancement to a subsequent step.



The home key returns the flow meter to the home screen from any other screen.



The delete key clears the last character entry, exits a pull down list, or closes an open window.



In addition to typing the decimal/period, this key can be used to navigate up one screen at a time.



The ± key can be used to navigate down one screen at a time, and also to adjust screen contrast, when used with the up/down arrow keys.

2.1.2 Connecting to the Signature with Flowlink

With Flowlink software version 5.1.510 or later, you can set up, program, and download data from the flow meter through its browser. Connection between the flow meter can be direct, through the USB port on the front panel, or remote, with an internal cellular or ethernet modem.

USB Driver for Signature

In order for your computer to connect to the Signature flow meter through the USB port, you must have the correct driver installed. USB drivers for both 32-bit and 64-bit operating systems are included with your flowlink program.

To install the driver:

After installing Flowlink, navigate to its program directory, and then to the USB Driver folder, typically at C:\Program Files\Flowlink 5.1\USB Driver.

Here you will find two drivers:

4300Driver_x64.msi for 64-bit operating systems and 4300Driver_x86.msi for 32-bit operating systems.

Without the Signature connected to your computer, begin running the appropriate file for your operating system. When prompted, connect the Signature to your computer's USB port. You should see a message in the lower right corner stating that new hardware has been found at the appropriate com port number.

Ensure that the Signature flow meter is connected to the computer before launching Flowlink.

Connect window

You can connect with the Connect window, or if you have connected with this site before, highlight the Signature site file in the workspace (left column in Flowlink) and select Item > Connect.

In the Connect window, select the Type of connection.

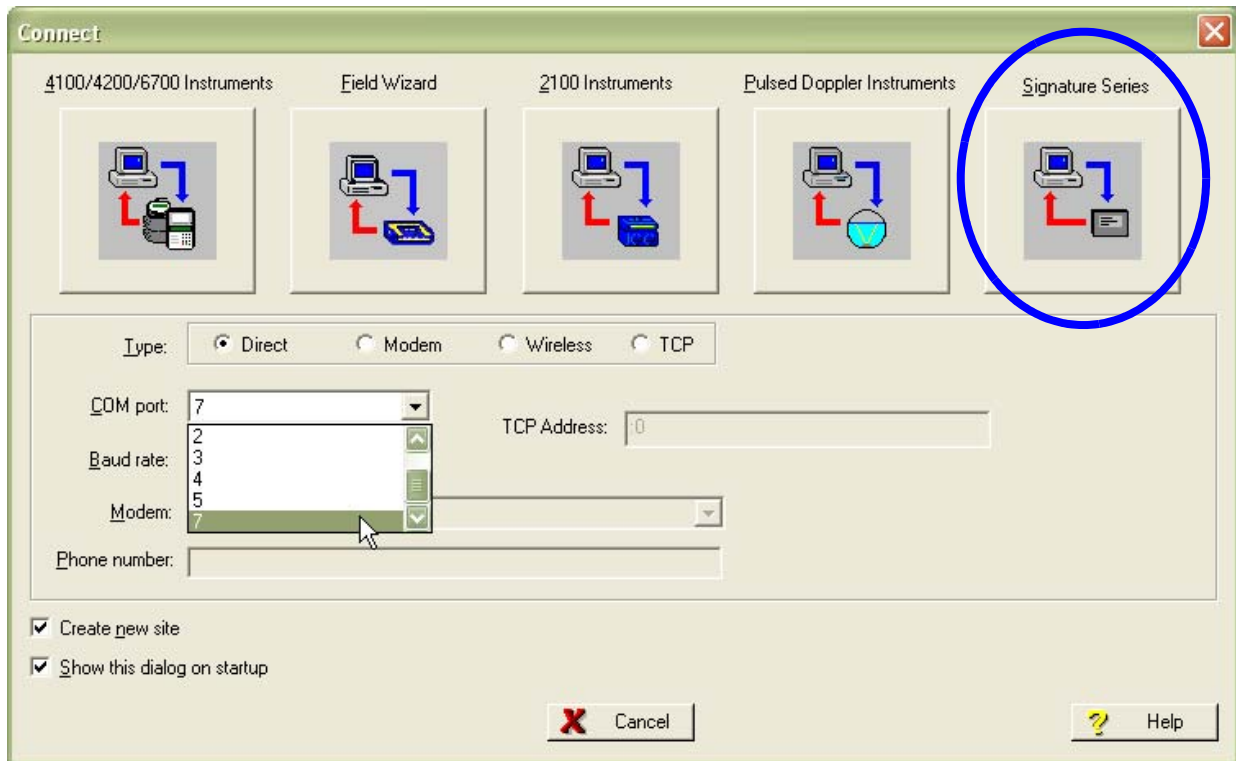

Figure 2-1 Flowlink Connect screen

Direct connection is made through the USB port. From the COM Port pull down list, select the port associated with the Signature.

TCP connection is made from the computer to the Signature flow meter's optional CDMA, GSM, or Ethernet modem. Enter the correct static IP and port number, separated by a colon, the correct public domain address.

If you do not want the flow meter matched with an existing site in the database, select the Create new site check box. (If this is the first time the flow meter is connected to Flowlink, a new site will be created automatically.)

Then click the large button under the heading Signature Series.

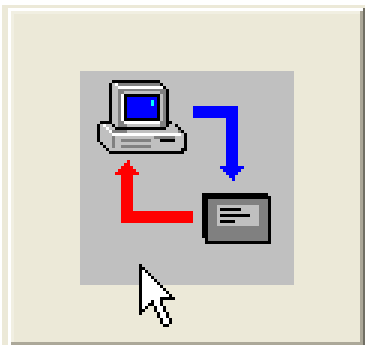

Site Screen

The Signature site screen has three tabs:

Site Info contains information specific to this site. Enter all relevant information into the Site Info fields, including the desired Site Name, and save the information by clicking Apply.

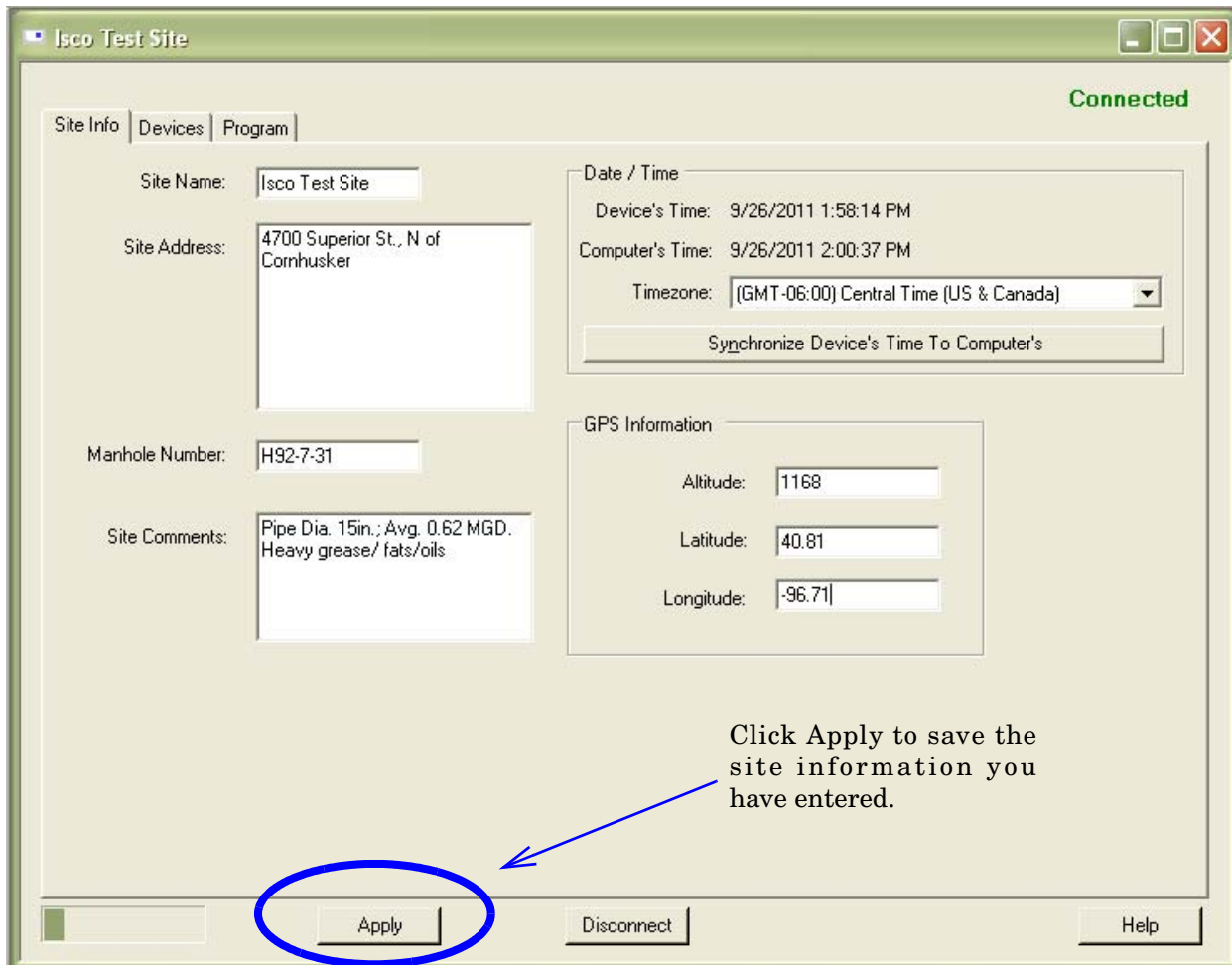

Figure 2-2 Site Info tab

Devices lists the name, software version, and hardware version of the flow meter for offline viewing of the site file.

This information, along with that of any connected TIENet devices, can be viewed from the specific flow meter's firmware (refer to *Sensor Diagnostics*, on page 2-28).

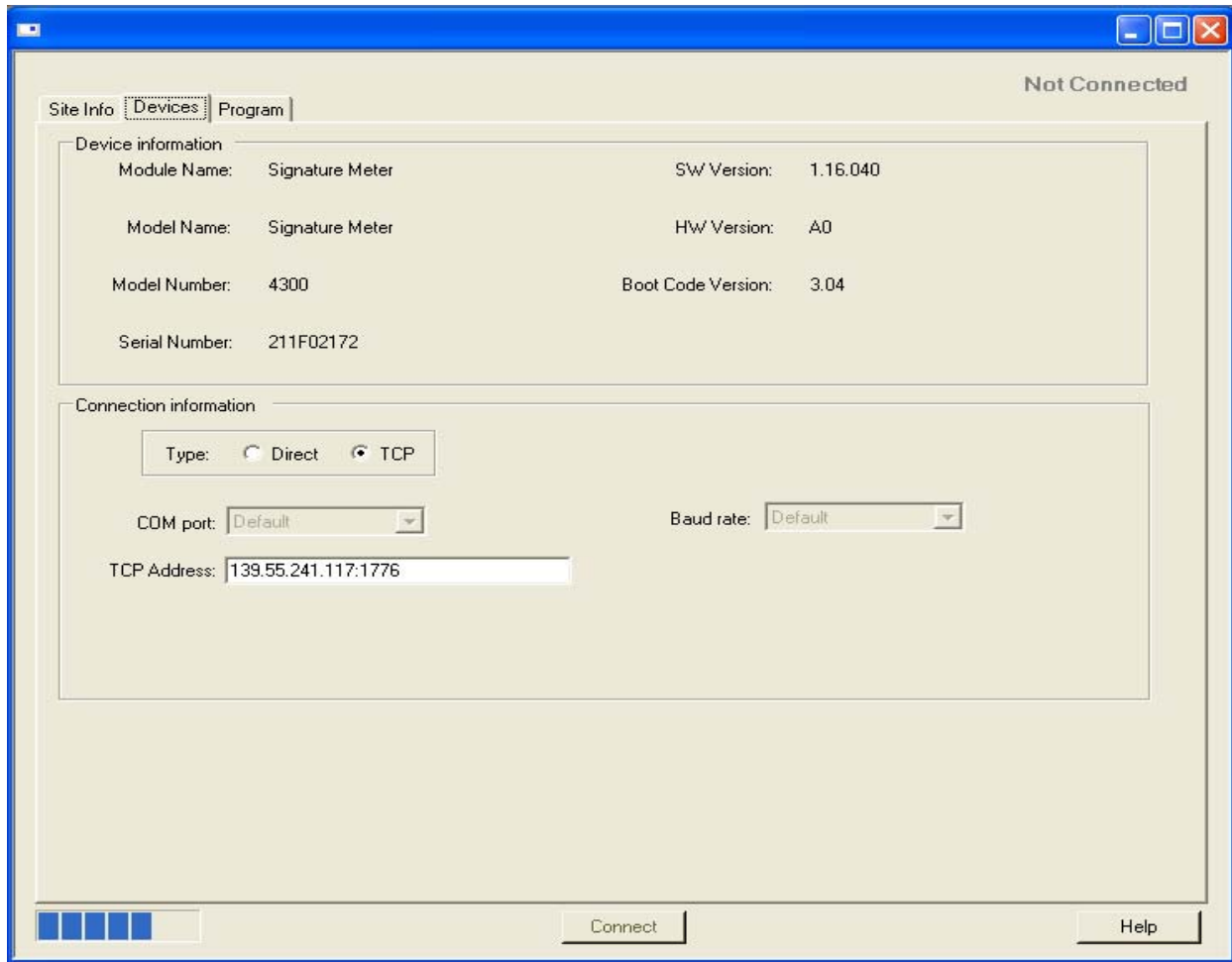
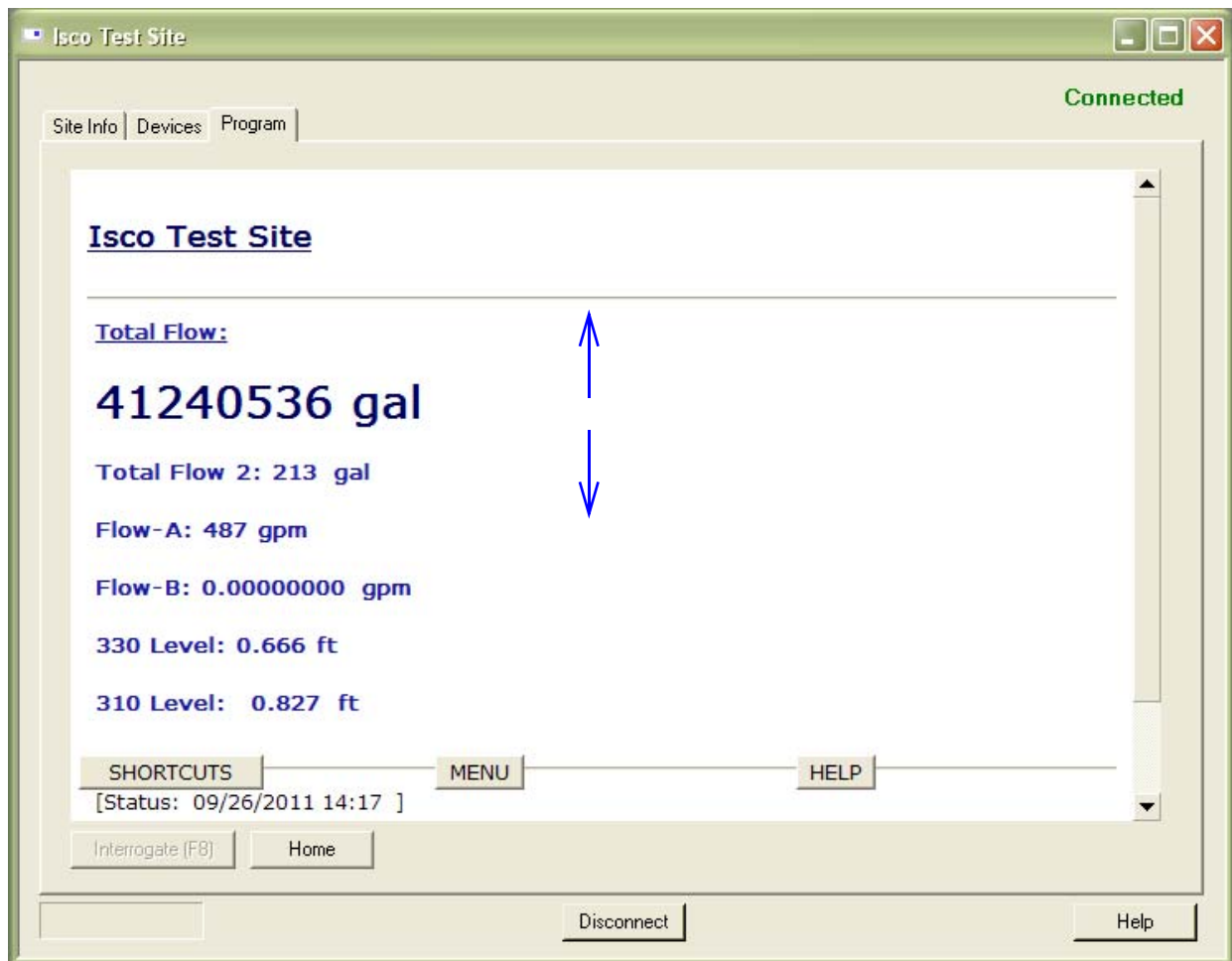

Figure 2-3 Devices tab

Program is the portal through which you access the Signature browser. The programming functions and displayed data in the browser are functions of the flow meter firmware, not Flowlink.



The Browser Window view (above) mirrors the Control Panel display (at left)

Figure 2-4 Program tab: Accessing the browser

2.2 The Home Screen

The home screen, or run screen, is displayed when the flow meter is in normal operating mode. This screen shows the current parameter readings and system status or alarm conditions.

A scroll bar on the right of the screen indicates there are more parameters off-screen that can be viewed by scrolling up or down.

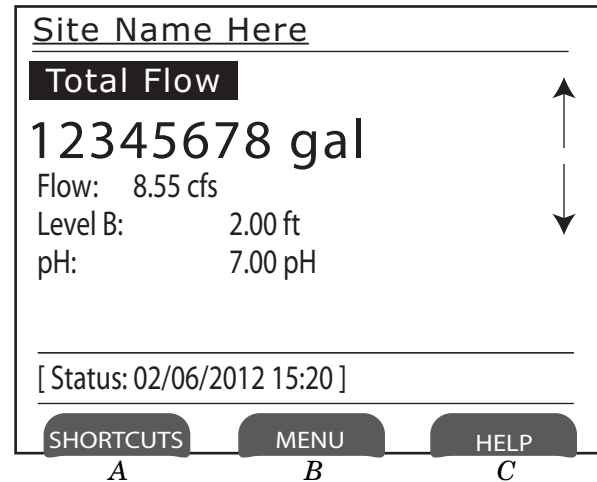

Figure 2-5 Home screen (normal operating mode)

2.3 Shortcuts

The Shortcuts menu provides quicker access to most commonly used commands, such as level adjustment or viewing data recorded over a period of time. Not all menu items described in this section will necessarily appear in your Shortcuts menu. The selections available in the Shortcuts menu are determined by what connected devices have been detected by the Signature flow meter. To access your shortcuts, press SHORTCUTS (**A**).

2.3.1 Level Adjustment

To set a new level, enter the value in the field next to Level, and select Adjust. To update the current reading, select Update.

2.3.2 Histogram

The histogram displays the measurements taken of up to three selected parameters in graphical format, beginning at your selected date/time, and spanning one to 48 hours. Enter a value in the Threshold field for a reference line. The measurements available for graphing are determined by what measurements are set up for data storage.

2.3.3 Report View

Reporting is set up from the Configure menu. **Summary** displays summaries of data measurements (i.e., Min/Max/Avg). **History** tracks user and meter events. **Program** tracks changes made to the flow meter's program configuration.

2.4 Programming

To access the setup/program menus, press MENU ().

When you press MENU, the four top menu options appear:

Hardware Setup detects all devices connected to the flow meter, establishes proper communication with them, and allows configuration of each device.

Configure sets up the measurement site and program parameters.

Administration dictates operating preferences and perform general housekeeping tasks.

Home returns to the home screen.

Additionally,

USB Options appears when a flash drive is connected to the USB port in the lower left corner of the control panel.

The program menus consist of steps and substeps. During programming, available subordinate menu content and steps will be determined by what you have previously entered, and what optional equipment is connected to the Signature flow meter.

2.4.1 Off-Screen Content



An arrow in the lower right corner of the flow meter's screen (see symbols at left) indicates that there is additional content on this screen in the direction the arrow is pointing. Use the arrow keys to access this content.

2.4.2 Character Grid



A small grid symbol in the lower right corner of the flow meter's screen (see symbol at left) indicates that the character grid is available.

Whenever you need to enter characters, such as letters, numbers, or punctuation, press Enter to display the character grid (Figure 2-6).

Use the arrow keys to navigate to the desired character and press Enter to select. When you are finished editing, select DONE and press Enter.

Isco Test Site														
Done			Cancel											
A	B	C	D	E	F	G	H	I	J	K	L	M	N	▲
O	P	Q	R	S	T	U	V	W	X	Y	Z	a	b	
c	d	e	f	g	h	i	j	k	l	m	n	o	p	
q	r	s	t	u	v	w	x	y	z	/	:	!		
@	#	\$	%	^	&	*	()	-	_	+	=	<	
>	?	,	.											▼

Figure 2-6 Character grid

2.4.3 Pull Down Menus

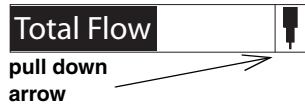

Fields with a pull down arrow next to them (see example at left) indicate a pull down list. Use the arrow keys to navigate between fields on the screen; when you highlight a pull down field, press Enter to display the items on the list. Then use the arrow keys and Enter to select from the list.

2.5 Program Steps (Menu Trees)

The program steps in Figures 2-7 through 2-20 show the overall menu sequencing.

An explanation of each program step, and information specific to connected devices, is provided in Sections 2.6 *Hardware Setup*, 2.7 *Configure*, 2.8 *Administration*, and 2.10 *USB Options*. This information can also be viewed by pressing the Help softkey on your Signature flow meter or its browser screen.

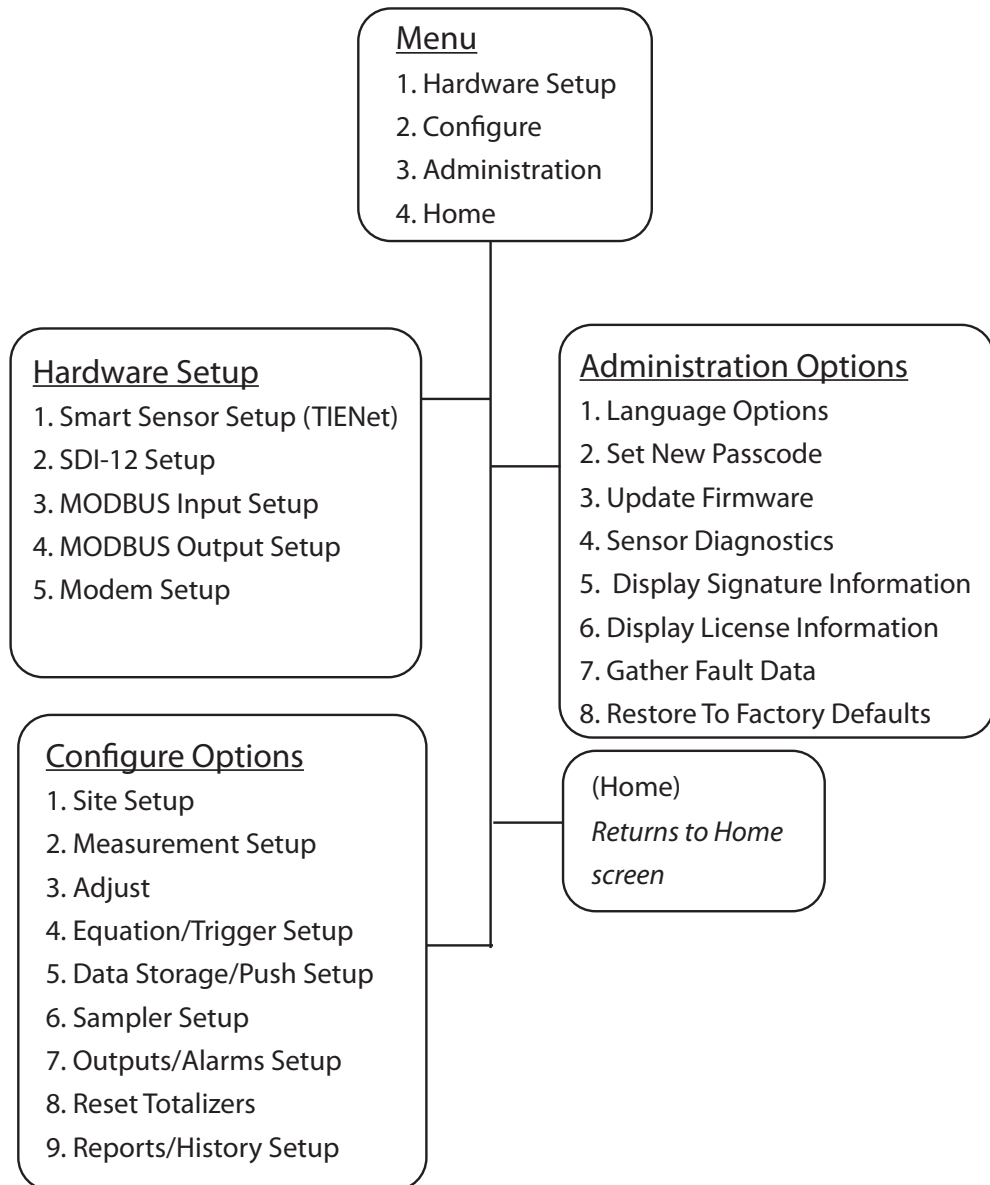

Figure 2-7 Menu Tree: Top menu

2.6 Hardware Setup

From the Hardware Setup menus, the flow meter detects and configures all connected devices.

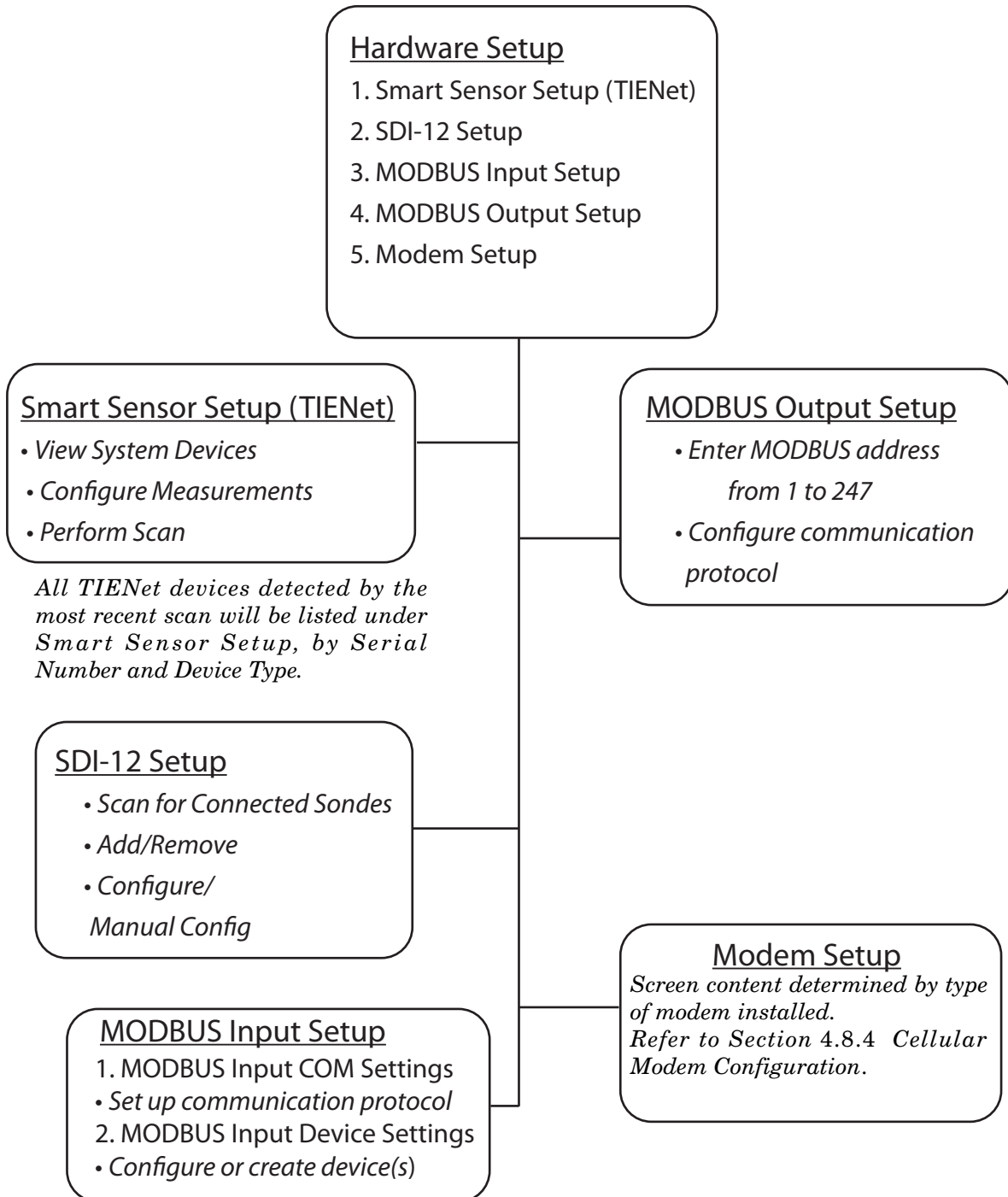

Figure 2-8 Menu Tree: Hardware Setup

**2.6.1 Smart Sensor Setup
(TIENet)**

Perform Scan

This selection will display the most recently detected TIENet devices connected to the Signature flow meter.

If TIENet devices have been added or removed from the system, highlight Perform Scan and press Enter to detect the current system configuration.

Sensor Differences

If there are any differences in the device configuration since the last scan, a list of Sensor Differences will appear.

Missing Sensors – The Missing Sensors list will indicate any previously connected devices that are no longer detected. Select **Retain** to keep the identification information for a previous device; select **Remove** to delete it.

Replaced Sensors – The Replaced Sensors list displays any newly added sensors that have replaced Missing Sensors that have been Retained.

Additional Sensors – Displays any newly detected devices.

Following a scan, selecting NEXT from Sensor Differences will navigate to Configure Measurements.

Configure Measurements

Navigate to Configure Measurements to begin setting up measurement parameters for each TIENet device detected.

To activate a measurement, highlight the radio button next to it and press Enter. To change the name of the measurement, highlight the name and press Enter.

Regardless of what you name them, the measurement parameters for each device remain the same. For your reference, Figure 2-9 on the following page shows the position of each measurement for each type of TIENet device.

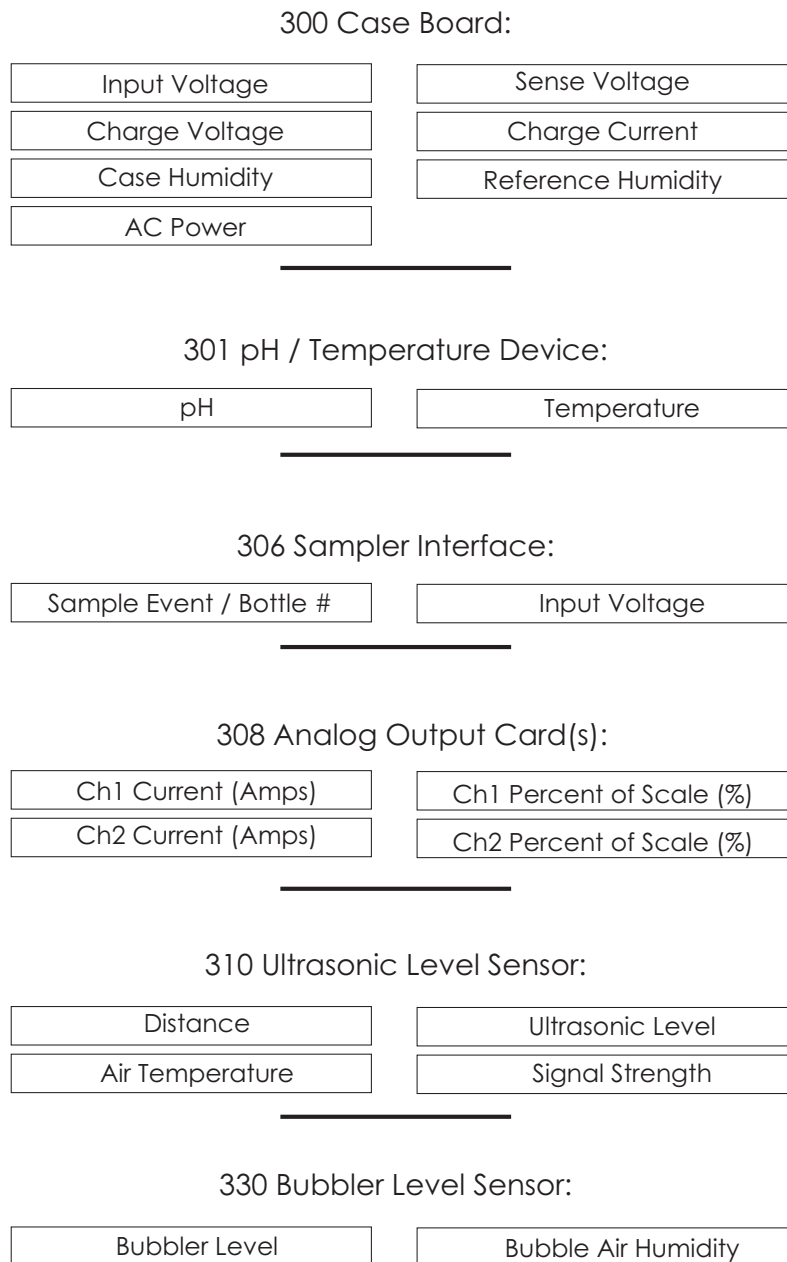

Figure 2-9 Measurement parameters for each TIENet device

2.6.2 SDI-12 Setup

Sondes detected since the last scan are displayed, with the activated sondes in the top box. If SDI-12 devices have been added or removed from the system, select Scan to detect the current system configuration. Following the scan, add/remove sondes from the Active list by selecting the sonde and clicking Add or Remove. To begin using an Isco-Ready sonde with its configured parameters, select Configure.

2.6.3 Modbus Input Setup

Table 2-1 below provides an example of Modbus settings for a connected DGH analog converter. The letters in the left column correspond to the entry fields shown in Figures 2-10 and 2-11.

The **multiplier** and **offset** are used to scale the raw number coming from the Modbus register(s) to represent the data in the units of measure you specify, as expressed in the following equation:

$$\mathbf{H} \text{ in units of measure} = (\text{register value} * \mathbf{J}) + \mathbf{K}.$$

In this example, the current input represents a flow rate where:

$$4\text{mA} = 0\text{cfs, and } 20\text{mA} = 10,000\text{cfs}$$

The D1252M documentation states that it produces a register value of 0 at 0mA, and 65535 at 25mA. This means that at 4mA the register will report 10485, and at 20mA it will report 52428.

The multiplier (J) is calculated as follows:

$$10,000 / (52428 - 10485) = -2500$$

Before setting up the Modbus input function, it is recommended that you print this page and use the empty columns provided on the right to fill in your own Modbus information.

Table 2-1 Example Modbus Input Settings						
	Manufacturer	DGH	Manufacturer		Manufacturer	
	Model	D1252M	Model		Model	
A	Protocol (ASCII/RTU)	ASCII	Protocol (ASCII/RTU)		Protocol (ASCII/RTU)	
B	Baud Rate	9600	Baud Rate		Baud Rate	
C	Data Bits	8	Data Bits		Data Bits	
D	Parity	None	Parity		Parity	
E	Stop Bits	1	Stop Bits		Stop Bits	
F	Device Name	D1252M	Device Name		Device Name	
G	Address	11	Address		Address	
H	Parameter	Flow Rate X	Parameter		Parameter	
I	Address ^a (Register)	30001	Address (Register)		Address (Register)	
J	Multiplier ^b	.238422	Multiplier		Multiplier	
K	Offset ^b	-2500	Offset		Offset	
L	Byte Order ^c (Endian)	Little	Byte Order (Endian)		Byte Order (Endian)	
M	Data Size (Format)	Unsigned Word	Data Size (Format)		Data Size (Format)	
N	Data Type	Flow Rate	Data Type		Data Type	
Q	Units	m ³ /s	Units		Units	

- a. For 2100 update interval in seconds must be written to register 26.
- b. For assistance in calculating a multiplier and offset, contact Teledyne Isco.
- c. Big Endian = Most significant register first; Little Endian = Least significant register first.

To begin configuring Modbus communication protocol and devices, select MODBUS Input COM Settings and use the pull down menus.

Add/Edit Device

Select Modbus Input Device Settings. Enter the device name, and the device address. For Request Timeout, enter a connection retry interval in milliseconds, and the number of attempts before a connection failure is determined.

Configure Modbus communication protocol using the pull down menus. To add/edit parameter(s) for the device, select Edit Parameters.

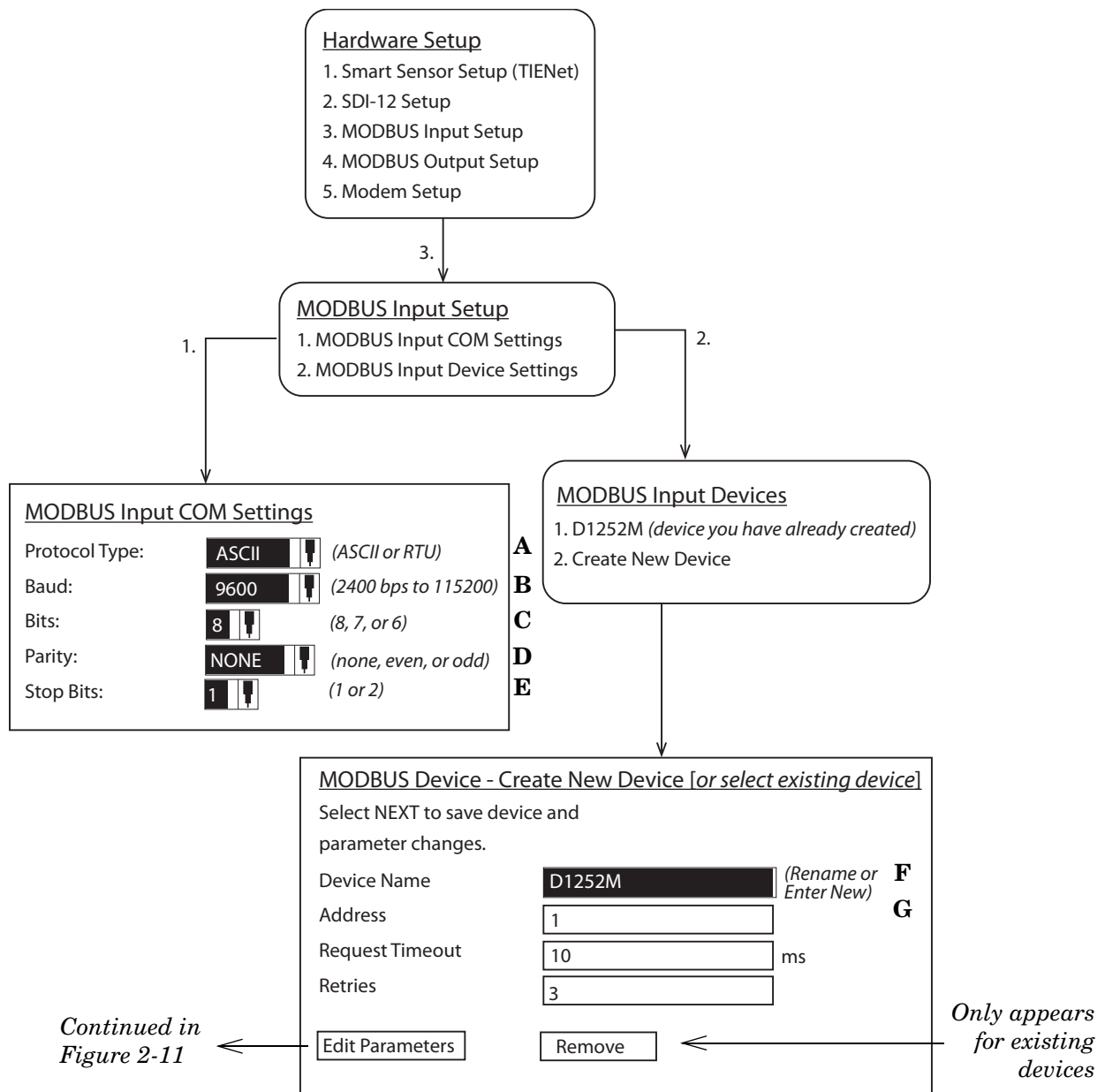

Continued in Figure 2-11

Only appears for existing devices

Figure 2-10 Modbus Input Setup

✓ Note

External Modbus RTU devices cannot use addresses 1 through 10.

Add/Edit Parameters

Select an existing parameter to edit, or select Add to add a new parameter for the device. Enter a name (such as a data type), and the register address. Use the pull down menus to select other parameters.

Select Little if a multiple register parameter has the low-order data in the first register; select Big if high-order. Select data size. The available Units of Measure are determined by the data type you select.

If necessary, enter a Multiplier and Offset so the register reports a value in the units specified.

Edit Device Parameters - [parameter name]
Go BACK to the Modbus Device page in order to save changes.
1. [Existing parameter]
2. Add



<u>Edit Parameter</u>	
Name	<input style="width: 100%;" type="text" value="Flow Rate X"/>
Address	<input style="width: 100%;" type="text" value="30001"/>
Multiplier	<input style="width: 100%;" type="text" value=".238422"/> (to scale the register)
Offset	<input style="width: 100%;" type="text" value="-2500"/> (offset applied to scaled register)
Byte Order	LITTLE <input type="checkbox"/> <input checked="" type="checkbox"/> (little or big)
Data Size	Unsigned Word <input type="checkbox"/> <input checked="" type="checkbox"/> (bit, bytes, signed, unsigned, float)
Data Type	Flow Rate <input type="checkbox"/> <input checked="" type="checkbox"/>
Units	m3/s <input type="checkbox"/> <input checked="" type="checkbox"/> (available UOM determined by data type selected)

H
I
J
K
L
M
N
O

Figure 2-11 Editing Modbus device parameters

2.6.4 Modbus Output Setup

The Modbus 485 output function enables a SCADA system to retrieve site data from the flow meter. Enter the Signature's address (from 1 to 247) and configure the communication protocol.

For Modbus register numbers and definitions, contact the factory.

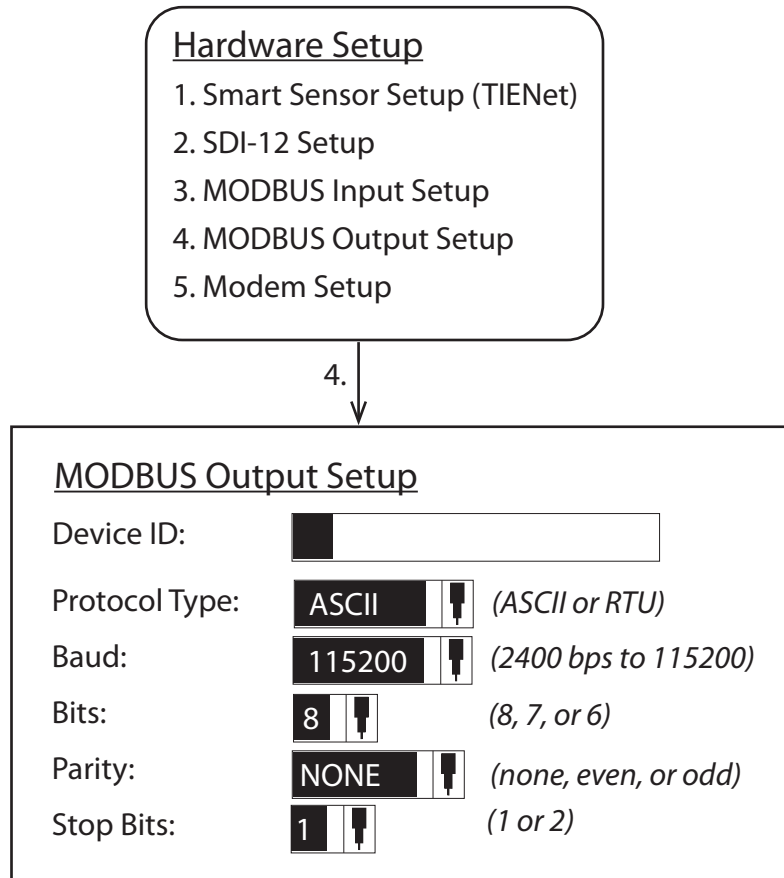

Figure 2-12 Modbus Output Setup

2.6.5 Modem Setup

The menu choices displayed for modem setup depend on which modem option is installed in the flow meter. For detailed information about installation and operation of Ethernet, GSM, and CDMA modems, refer to Sections 4.7 *Ethernet Modem* and 4.8 *Cellular Modems*.

2.7 Configure

The Configure menu is used for setting up the measurement site and setting the program parameters.

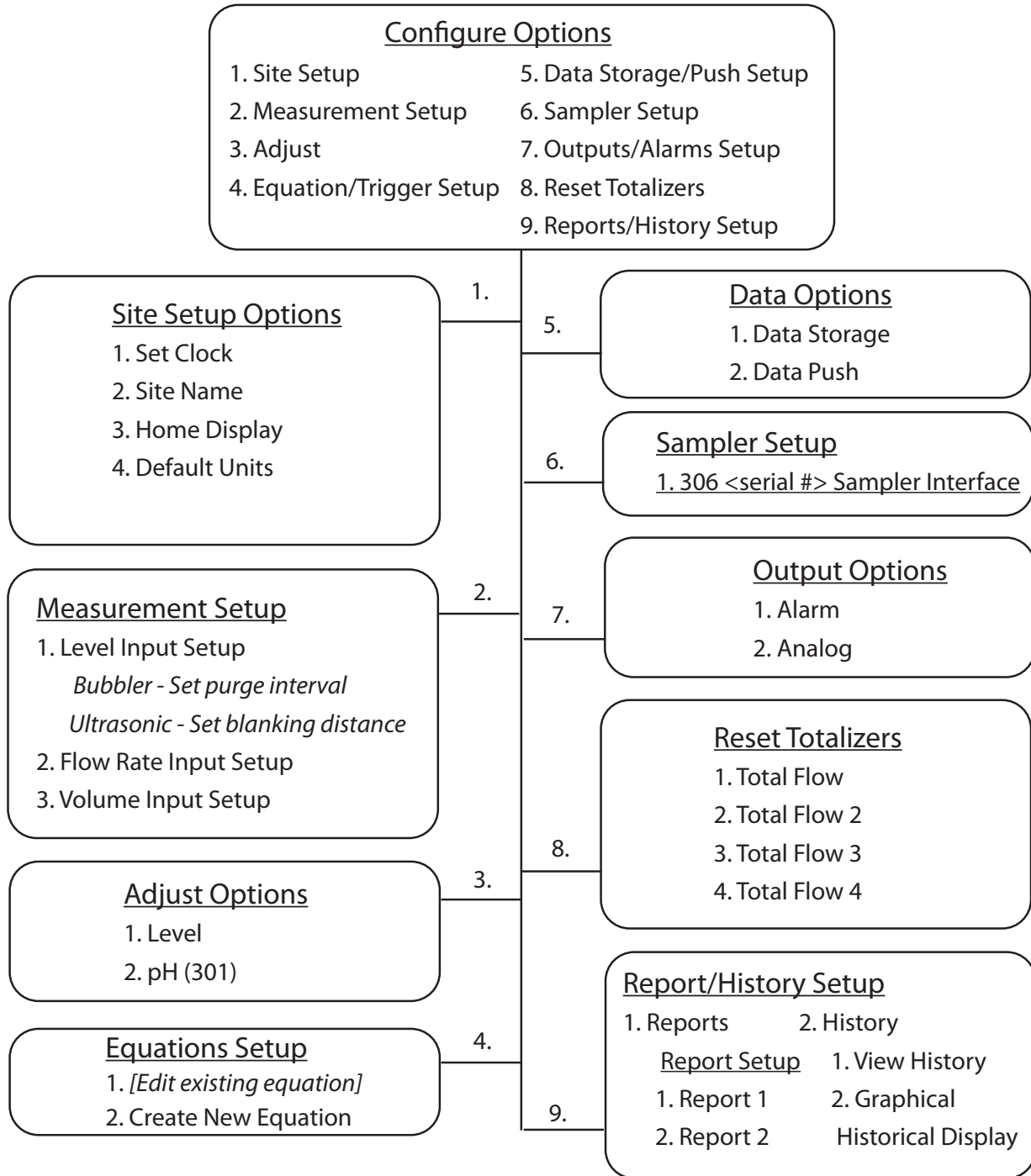

Figure 2-13 Menu Tree: Configure

2.7.1 Site Setup

The Site Setup menu sets some basic operating characteristics specific to the site.

Set Clock – Enter Year, Month, Day, Hour, Minute.

Site Name – Press Enter to display the character grid. Select one character at a time to create the desired site name.

Home Display – The Home Display determines how current measurement data is displayed on the Home screen.

From the Measurements Setup screen, select all measurement parameters to be displayed. The parameters available in the pull down menus will be determined by what devices are connected to the Signature meter.

Default Units – To set units of measure for each parameter, first select the parameter from the menu list.

The available units of measure that appear will be determined by the parameter you have selected. Under Units, highlight the units of measure and press NEXT. When finished, press NEXT again to save and exit.

2.7.2 Measurement Setup

This menu is for setting up the level measurement (Level Input Setup), flow conversion (Flow Input Setup), and flow volume totalizer(s) (Volume Input Setup). Menu items that appear are dependent on what equipment is connected to the Signature flow meter.

Level Input Setup – Under Level Setup, select the level input. Usually there will only be one listed, unless your system is using more than one level measurement device.

For the TIENet 330 bubbler, the purge function is a periodic burst of air forced through the bubble line to keep it free of debris. Select the purge interval between 15 minutes and 8 hours from the pull down menu.

Flow Rate Input Setup – Measurement settings and flow conversion are programmed for the flow rate(s) from this menu (refer to Figure 2-14 on the following page). If more than one flow rate data set is being calculated, these settings are programmed separately for each one.

1. Select the flow rate to set up.
2. From Measurement Settings, select the Level Input to be used in the flow calculation and the Measurement Rate (interval). Enter the name for this flow rate.
3. Select the flow conversion type to be used (Weir, Flume, Metering Inserts, Manning Formula, Equation, or Data Points); then set up the conversion.

 Note

Additional information about flow conversions can be found in the *Isco Flow Measurement Handbook* included with the Signature Flow Meter.

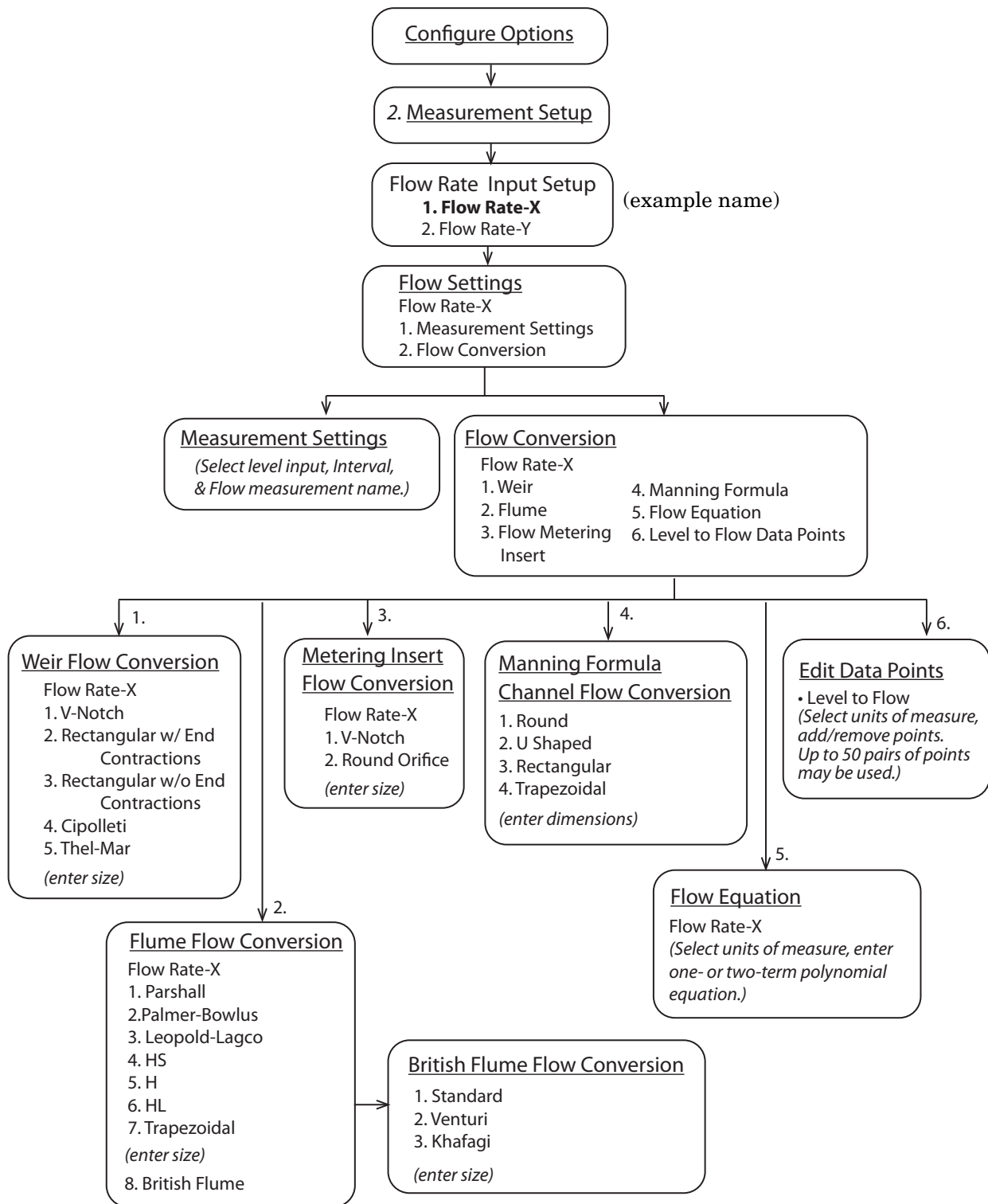

Figure 2-14 Menu Tree: Flow measurement setup

Volume Input Setup – You can set up one to four Total Flow measurements. Select the flow rate(s) used for total volume, the totalizing method (Net, Positive, or Negative), and the interval at which the total flow will be updated (between 30 seconds and 24 hours).

From the Resolution pull down menu, select the degree of resolution required for your total flow (lower = fewer digits to right of decimal; higher = more digits to right of decimal).

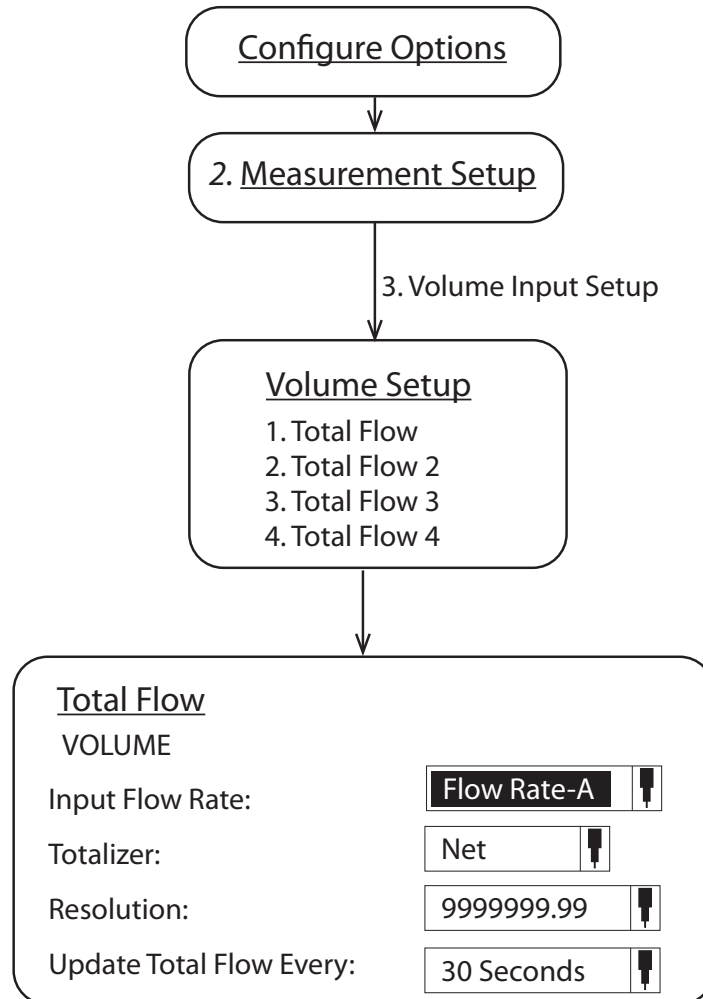

Figure 2-15 Menu Tree: Volume Input Setup (total flow)

2.7.3 Adjust

Adjust levels and/or calibrate measurement values for connected TIENet devices. Level adjustment can only be performed following installation at the measuring site. Level adjustment instructions can be found in Section *Level Calibration*, on page 3-20.

Note

For detailed instructions on calibration of a connected TIENet 301 pH device through this menu selection, refer to the 301 user manual.

2.7.4 Equation/Trigger Setup

Conditions are sets of site-specific, user-defined parameters. Refer to Figure 2-16 on the following page.

Equations are created from various site conditions that can be used to generate alarms, log or push data at secondary rates, trigger a connected sampler, or conserve power by turning on equipment only when needed.

Types of conditions

There are five types of conditions provided:

Range – TRUE when a measured parameter value is inside or outside specified upper and lower limits.

Rate of Change – TRUE when a measured parameter changes by a specified amount over a specified time duration.

Sensor Error – TRUE when a sensor error is present for a specified time duration.

Threshold – TRUE when a measured parameter reaches or exceeds a user-defined setpoint.

Time Table – TRUE when the flow meter's internal clock is within a defined time duration. This may be a weekly, daily, or specific one-time stop/start time.

Defining conditions

To define a condition:

1. Highlight the desired condition in the lower left corner of the screen (Conditions A-F).
2. Highlight Edit Condition and press Enter.
3. Scroll down and press Enter to select the type of condition (listed above). Press NEXT to go to the configuration screen for that condition type. Press NEXT when complete.

The condition in the left-hand corner of the screen will now show the condition type.

Building equations

Build or modify the equation by navigating to the desired conditions and operators. Highlight Select Condition and press Enter again to add it to the equation. Press Enter to add a highlighted operator.

Press NEXT when complete.

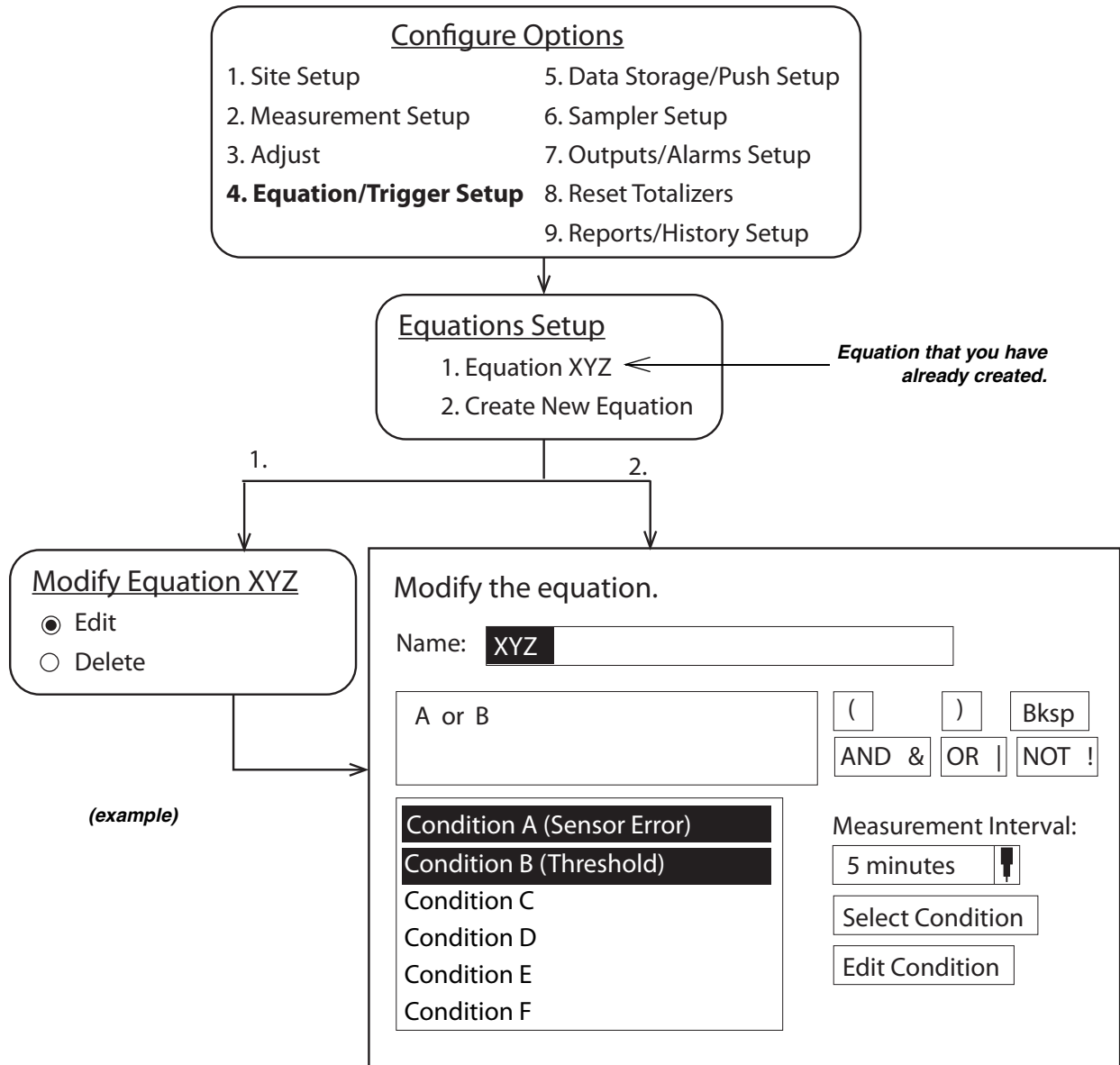

Figure 2-16 Defining conditions & building equations.

2.7.5 Data Storage/Push Setup

Data Storage – Set up data storage rates for a group of measurements, or separately for individual measurements. Scroll to the bottom of the screen to set up the primary storage rate, and a secondary one, if needed, with its trigger equation.

Data Push – Set up the flow meter to push data to a server running Isco Flowlink Professional software (internal modem required).

2.7.6 Sampler Setup

Program the flow meter to trigger and pace a sampler, and receive sampling information from the sampler.

Note

For detailed instructions on configuring a connected TIENet 306 Sampler Interface through this menu selection, refer to the 306 user manual.

2.7.7 Outputs/Alarms Setup

Alarm – Configure Local, SMS text, or Server alarms based on user-defined site conditions. Under Alarm, select an alarm from the list or set up a new alarm.

Next, select an Alarm Trigger from the pull down list.

Note

The trigger(s) listed in the Alarm Trigger pull down list consist of equations you have already created based on your defined site conditions (refer to Section 2.7.4 *Equation/Trigger Setup*).

Alarms: Local

Local alarms are viewed on the Signature Flow Meter itself. When a programmed alarm condition becomes true, the LED on the front panel glows red.

To view the alarm message, press the Alarm softkey ().

For local alarm setup, refer to Figure 2-17 on the following page.

Alarms: SMS / Server

SMS and Server alarms require an optional internal modem. To configure your modem for communication, refer to Section 4.7 *Ethernet Modem* or Section 4.8 *Cellular Modems*.

Note

Server alarms notify a specified list of contacts in the event that a server running Flowlink Pro fails to receive pushed data from a site within a specified duration.

For SMS and Server alarm setup, refer to Figure 2-18.

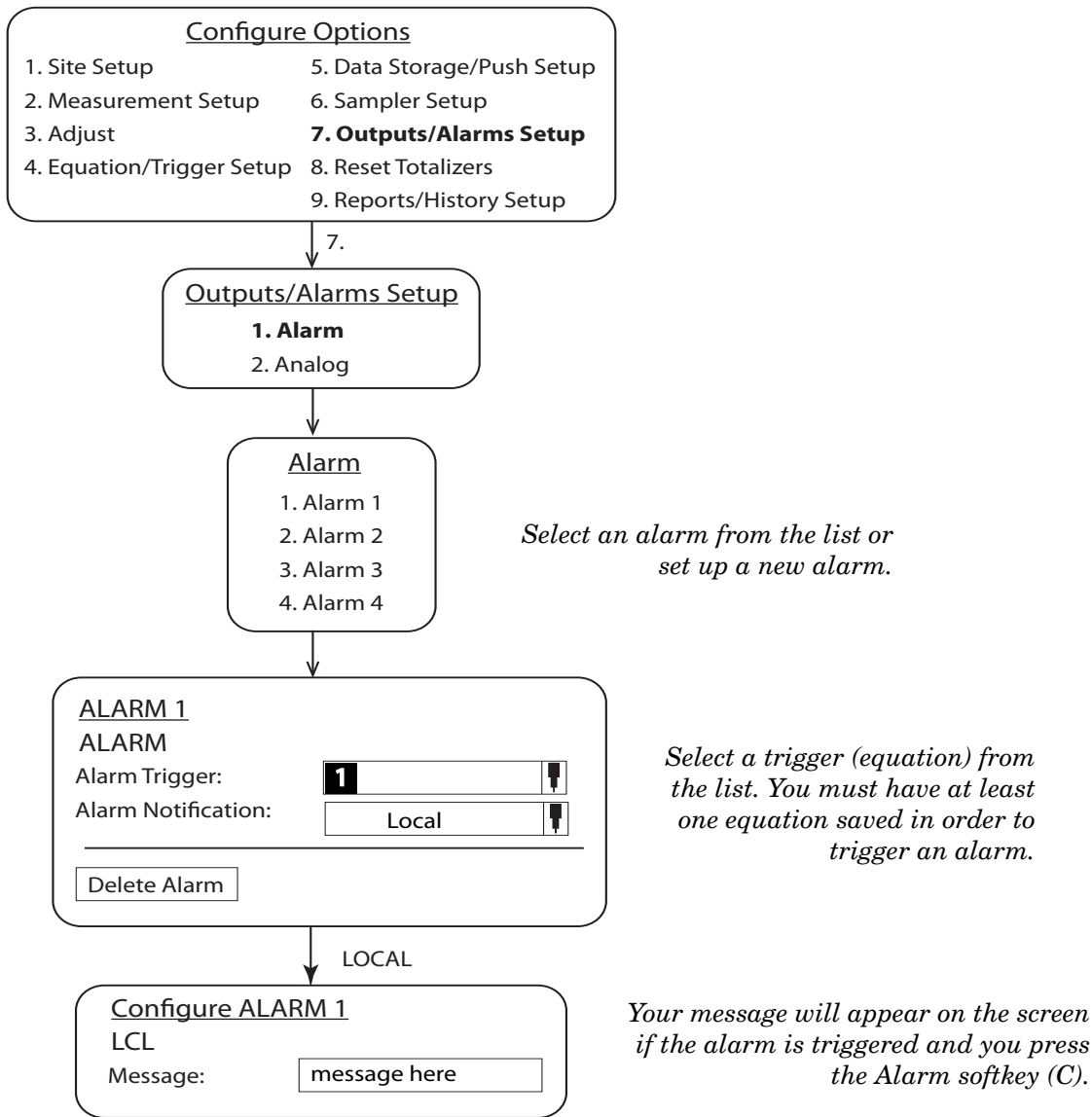

Figure 2-17 Local alarm setup

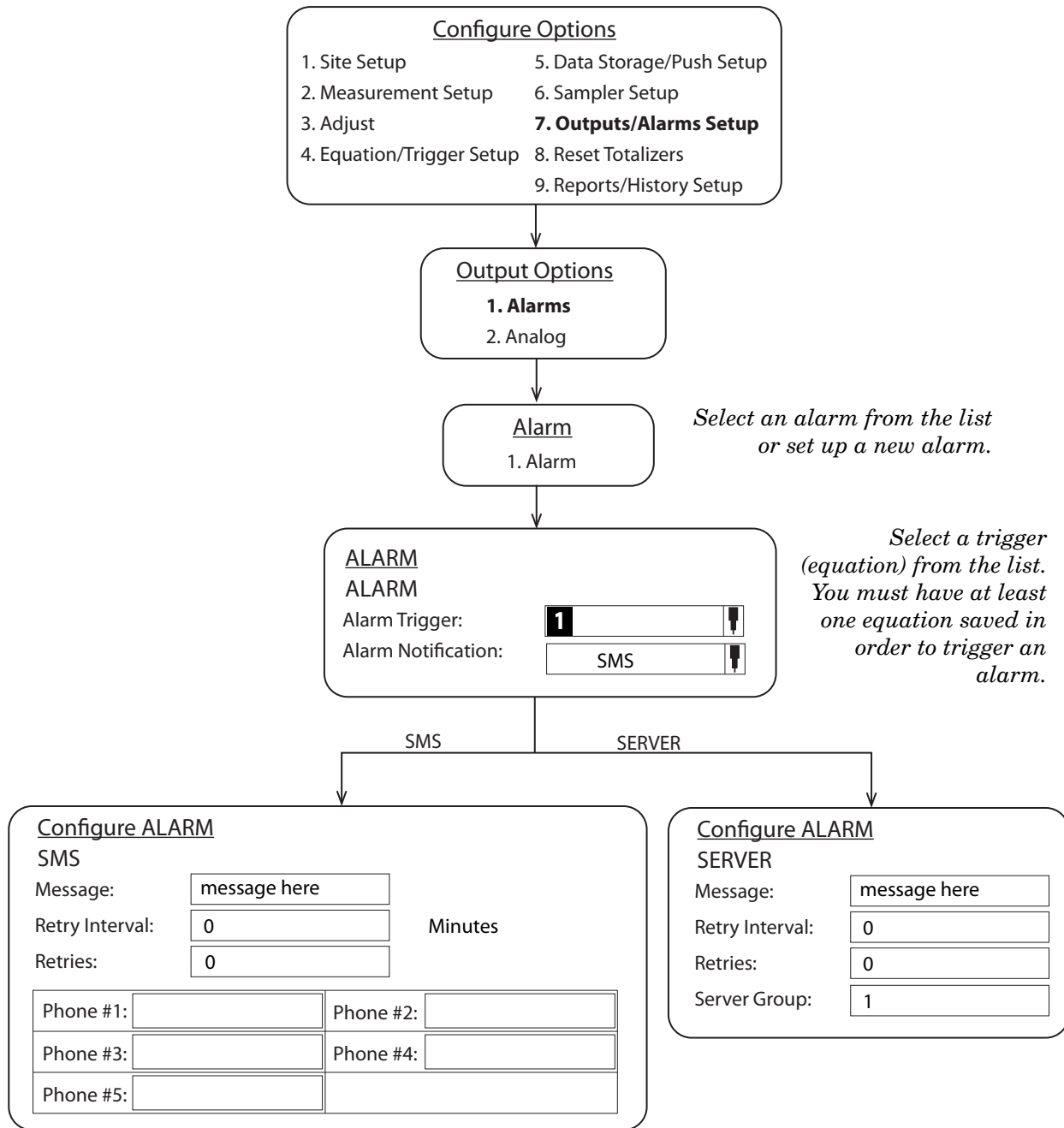

Figure 2-18 SMS and Server alarm setup (modem required)

Analog – Select the output to configure, then select and configure the measurement the output will represent. TIENet 308 option card required (see Section 4.4.6 *Analog Current Output*).

2.7.8 Reset Totalizers

Select the flow volume totalizer(s) to be reset. Selection resets the totalizer to zero.

2.7.9 Reports/History Setup

Reports – Set up report interval and measurements to include for one or two reports.

History – Display user and meter events (i.e., log-ins, adjustments, data push, etc.), and/or set up the graphical display for selected measurements over a period of time.

2.8 Administration

Administrative settings (see following page) dictate operating preferences and perform general housekeeping tasks.

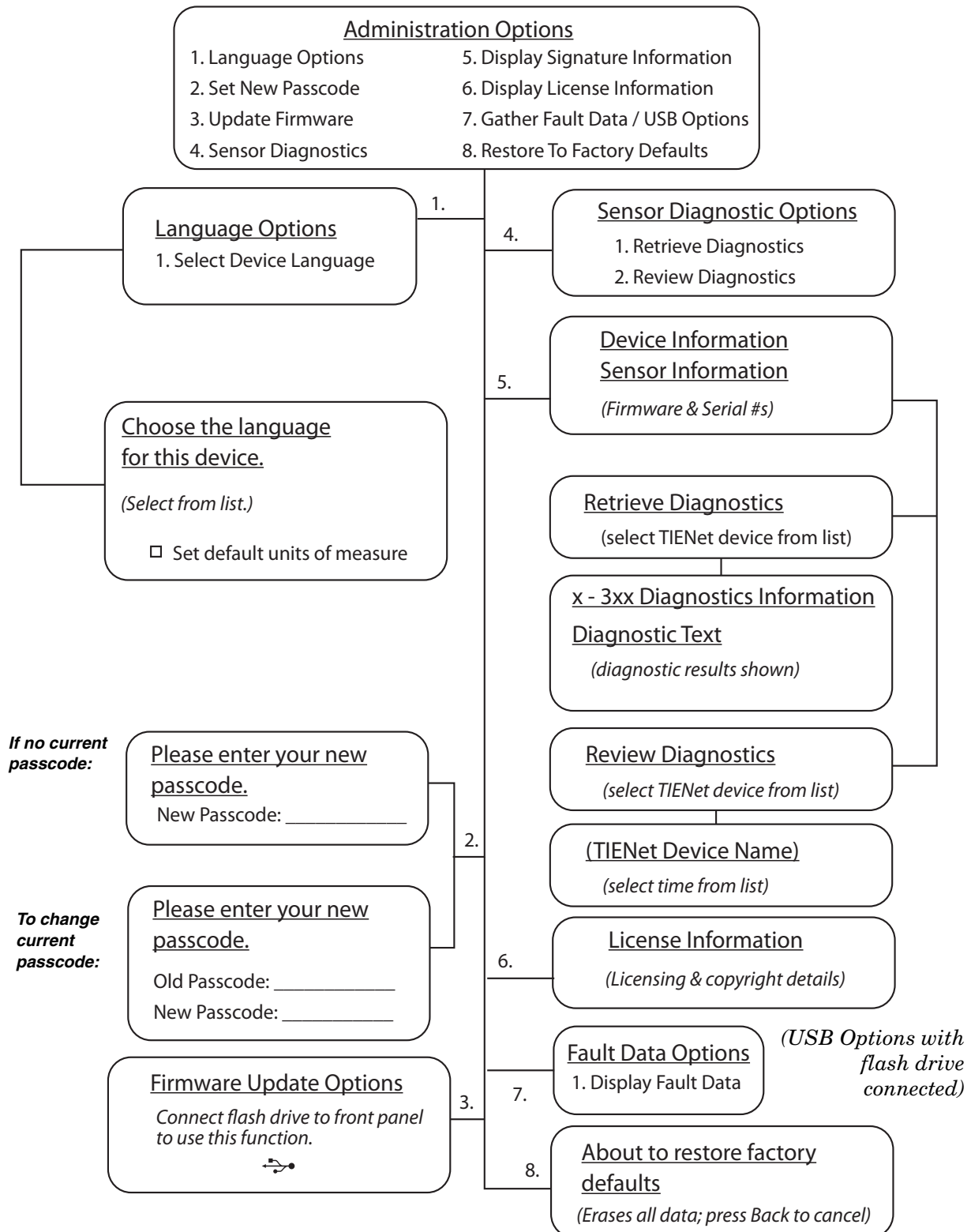

Figure 2-19 Menu Tree: Administration

2.8.1 Language Options

Select Device Language – From the list, select the default language to be displayed by the Signature flow meter. Available languages include:

English (USA)	Dansk	Português (Brasil)
English (International)	Nederlands	Español (México)
Français	Türk	Svenskt

From this screen, you may also set general default Units Of Measure to USA or International. You may still select units of measure for individual measurements through Configure Options > Site Setup.

2.8.2 Set New Passcode

A numerical passcode can be set to protect access to programming and data. By default, the flow meter is not passcode-protected. To change an existing passcode, enter the current passcode, and then the new passcode. To remove the passcode requirement, enter a new passcode of 0 (zero).

2.8.3 Update Firmware

To use this function, first connect a flash drive loaded with the correct firmware update file(s) to the USB port. Refer to Section 2.10 *USB Options* for complete instructions.

2.8.4 Sensor Diagnostics

The Signature provides operating data for each connected TIENet device upon request, for site evaluation or troubleshooting purposes.

To generate a new diagnostic report, select **Retrieve Diagnostics**. The available devices can then be selected from a list. When the diagnostic data is available, press Enter to view it.

To view past diagnostic reports, select **Review Diagnostics** and select from the list of devices.

2.8.5 Display Signature Information

Select this option to view the serial number, model number, software revision, and hardware revision of the Signature flow meter and any connected TIENet devices.

2.8.6 Display License Information

This selection displays open-source licensing and copyright information for the Signature firmware.

2.8.7 Gather Fault Data

Fault data is a term describing the capture of any user and/or flow meter activity prior to and during a system error or failure. This data can be displayed to assist in troubleshooting. To download the data to a flash drive, connect a flash drive to the USB port on the front panel of the Signature and select Gather Fault Data from the USB Options menu that appears (refer to Section 2.10 *USB Options*).

2.8.8 Restore to Factory Defaults

This function returns the Signature Flow Meter to the program that was installed the factory. This is an example program that can be used for reference when designing your own program.

Be sure to record your own program settings and save all data before restoring the factory defaults.

2.9 Home

HOME returns to the home screen.

2.10 USB Options

The USB Options menu will only appear when you connect a flash drive to the USB port on the front panel of the Signature.

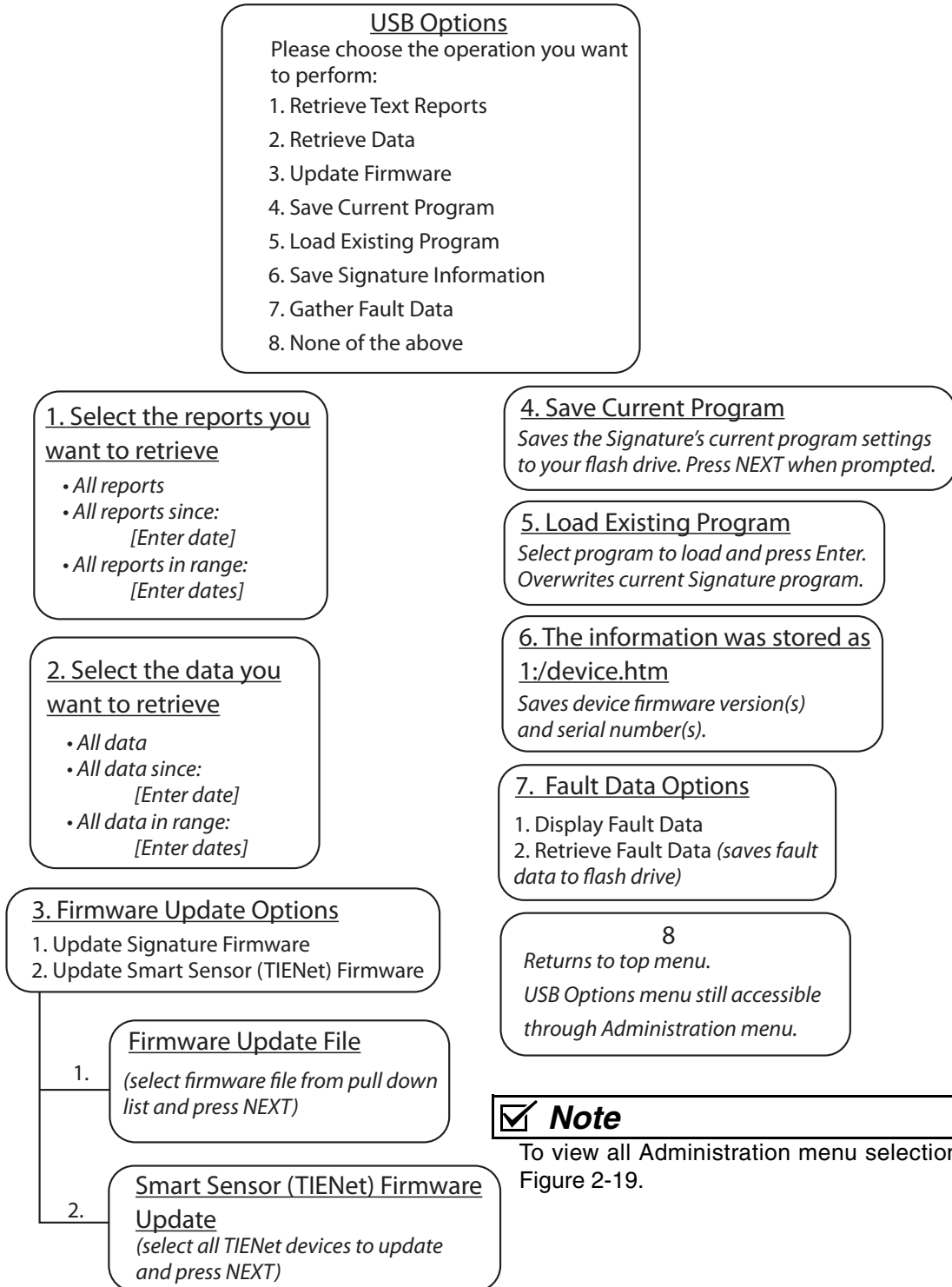

Figure 2-20 Menu Tree: USB Options

2.10.1 Retrieve Text Reports

Select this function to download the Signature data text reports for verification of data integrity.

The four event data types are:

Program Report – Tracks changes to the Signature Meter’s configuration

Summary Report – Documents summaries of data measurements (e.g. Min/Max/Avg)

Diagnostic Report – Tracks the occurrence of, and results from, diagnostic tests

History Report – Tracks user and meter events (e.g. level adjustments, calibration, data push, etc.)

Select “All reports,” or specify a start date or date range, and press NEXT. The reports will be stored on the connected flash drive, in text format, in a folder called “reports.”

This folder contains two sub-folders, named 1 and 2.

2.10.2 Retrieve Data

The program settings and flow data can be downloaded onto your flash drive in .ddp (data dump) format.

Select “All data,” or specify a start date or date range, and press NEXT. The data will be stored on the connected flash drive in a folder called “ISCO.”

This file can then be imported later into Flowlink, where it can be viewed in regular site file format, with the recorded data and report/graphing capability.

2.10.3 Update Firmware

With the flash drive connected, the firmware update functionality becomes available from the Administration menu.

Update Signature Firmware – Connect a flash drive containing the proper bin file in a top directory folder labeled BINFILE, to the USB port on the front panel of the Signature flow meter.

Select Update Firmware > Update Signature Firmware. Press Enter to open the pull-down menu and select the appropriate .bin file you want to install.

The update will run for approximately three minutes. When the firmware has been downloaded to the flow meter, remove the flash drive when prompted. An automatic reboot then occurs over a period of approximately five minutes, during which the green LED signals that an internal operation is in progress. Do not unplug the flow meter or press any keys until the home screen appears.

Update Smart Sensor (TIENet) Firmware – Connect a flash drive containing the proper bin files for your TIENet device(s) in a top directory folder labeled BINFILE, to the USB port on the front panel of the flow meter.

Select Update Firmware > Update Smart Sensor (TIENet) Firmware. Select the radio button next to each device to be updated and press Next.

The flow meter will display the progress of the sensor firmware update(s). A confirmation screen will appear when the update is complete.

2.10.4 Save Current Program Select this option to save a copy of the Signature's current program to your flash drive.

2.10.5 Load Existing Program Select this option to load a saved program from your flash drive. Note that selecting this option will cause the current program to be overwritten with the one from the flash drive.

In order for the Signature to load the correct program, the program file must be stored on the flash drive in a folder whose name is the same as that of the instrument.

2.10.6 Save Signature Information This option saves a snapshot of the firmware version(s) and serial number(s) of the Signature and any connected TIENet devices.

2.10.7 Gather Fault Data Fault data is a term describing the capture of any user and/or flow meter activity prior to and during a system error or failure. This data can be viewed and/or downloaded as a file to your flash drive to assist in troubleshooting.

2.10.8 None of the above This item returns the screen to the top menu. However, as long as the flash drive remains connected, the USB Options menu will still be active, and can be reopened from the Administration menu.

2.11 Signature Data in Flowlink

To download flow and event data from the Signature Flow Meter into the database with Flowlink, connect to the flow meter and select Interrogate (F8), or Import ddp (data dump).

2.11.1 Event Viewer By default, Flowlink's Event Viewer displays the four event data types in tabular format, with a time stamp and short description of the event for each entry (refer to Figure 2-21). Each event type is represented by a graphical symbol, located in the first column:



Program 

Summary Reports 1 & 2 

Diagnostic 

History (User / Meter Actions)  Meter Actions include Data

Push - start/fail/complete, and Power Up/Down; all other events are user events (i.e., calibration, changes to the program, totalizer reset, etc.).

If the data for that event is unaltered, a green check mark  appears next to it. If the data cannot be verified as authentic, a red slash  appears next to it.













Type	Auth	Event Time	Event Summary
		2/17/2011 11:00:00 ...	Report Signature Site Interval: 2011-02-18T06:00:00 to 2011-02-18T08:42:19 Voltage: 13.527621
		2/17/2011 11:00:01 ...	Report Signature Site Interval: 2011-02-18T10:00:00 to 2011-02-18T11:11:34 Voltage: 12.807129
		2/14/2011 11:00:00 ...	
		2/15/2011 7:20:30 PM	LOGGED_IN
		2/16/2011 1:41:30 PM	LOGGED_IN
		2/16/2011 3:22:50 PM	LOGGED_IN

Figure 2-21 Event Viewer in Flowlink

Printing reports

Select one or more rows in the viewer to be printed and then select the Print button.

Exporting reports

To save event data as a text report for future verification, highlight the desired row(s) in the Event Viewer table and click Export (or right-click and select Export).

The default destination is your My Documents folder; however, you can change this to another preferred destination, including a USB drive, if preferred. A message window will notify you when the export is complete.

The files you exported are saved using the following hierarchy:
 SITENAME \ MODULENAME \ DATE.

2.11.2 Verifying Exported Reports

Flowlink will only export already verified reports; they can also be verified after being exported.

Verification of exported data reports is done using the **Report Verification tool**, a small application installed separately when Flowlink was installed. This tool is located in the Flowlink program folder, normally at C:\Program Files\Flowlink 5.1, and

is identified with a traffic light icon  .

Note that this tool can also be used to verify data exported directly to a USB drive using the USB Options menu (refer to Section 2.10).

Use the top Browse... button to navigate to the desired report (*.txt) file. Use the bottom Browse... button to navigate to its corresponding authentication (*.ath) file. Click Verify. The application will quickly return a message showing the verification result.

Data is authentic.



Data has been altered.



Figure 2-22 Report file verifier

Signature™ Flow Meter

Section 3 Installation

This section contains physical preparation procedures and mounting methods for the Signature Flow Meter and associated Teledyne Isco equipment.

WARNING

The installation and use of this product may expose you to hazardous working conditions that can cause serious or fatal injury. Take all necessary precautions before entering a worksite. Install and operate this product in accordance with all applicable safety and health regulations and local ordinances.

3.1 Accessing the Interior

External device cables and mains line cord are passed, usually via conduit or cord-grip fittings, through the port holes in the bottom of the case and wired directly to the connector case.

Tinning unterminated wires prior to installation is recommended.

Tools Required:

- Small flat screwdriver (3.5mm)
- #2 Phillips screwdriver
- Channel locks
- Soldering iron (for tinning wires)

DANGER

Before opening the case, first ensure that mains power is disconnected from the unit.

CAUTION

Before opening the case, disconnect the optional battery backup power, if used.

Note

Before restoring mains power, ensure that the flow meter's USB connector does not have a cable attached.

Open the door to access the two large screws holding the front panel on the connector case. Remove the two screws.

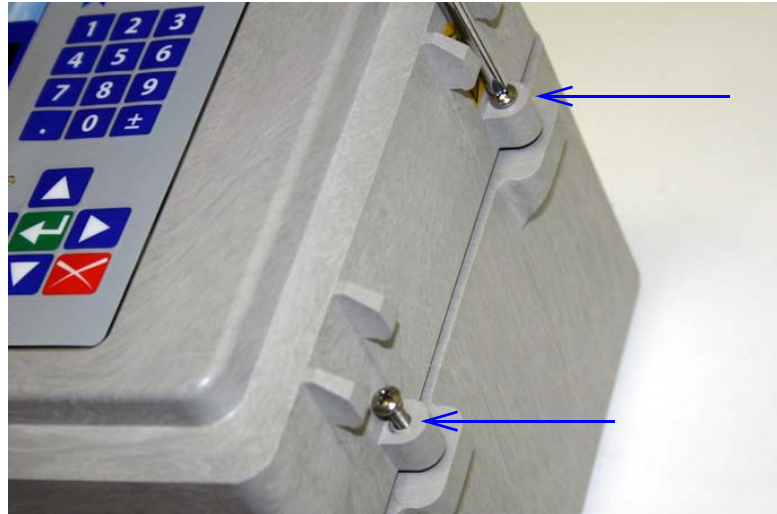

Figure 3-1 Open door and front panel to access interior

Open the front panel to access the connector case. Connectors on the board are identified in Figure 3-2.

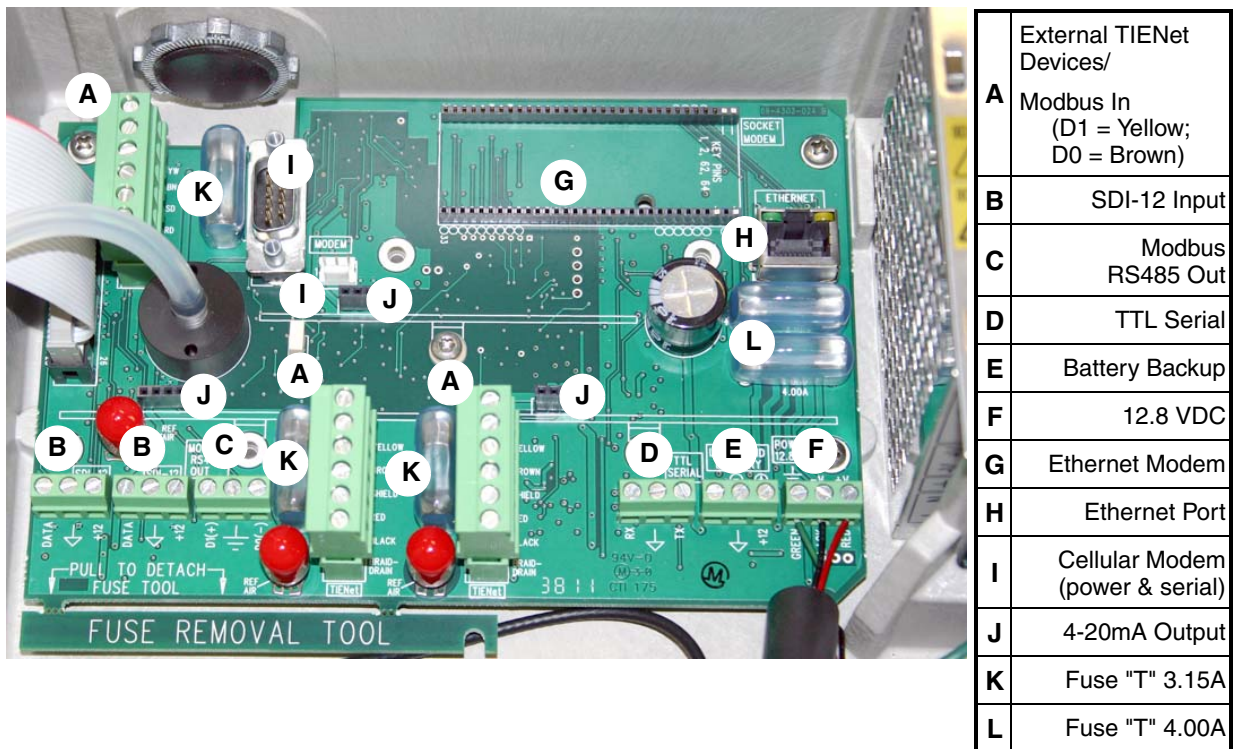

Figure 3-2 Connector case, connectors, and fuses

 **Note**

The three TIENet terminal strips (A) are interchangeable; any of the devices can be connected at any of the three locations.

3.2 Case Bottom Cable Entries

The connections made through the cable entries depend on the application, but their most common uses, in accordance with the connector case layout, are depicted below.

All optional cable entries must use appropriate ID conduit connections or cord-grip fittings to retain the IP68 rating. If you are using non-TIENet or non-Signature cables, you must supply the appropriate ID conduit connections or cord-grip fittings.

 **CAUTION**

If you are using conduit instead of the cord-grip fitting, the conduit and wires must be sealed to prevent harmful gases and moisture from entering the Signature enclosure. Failure to seal conduit could reduce equipment life.

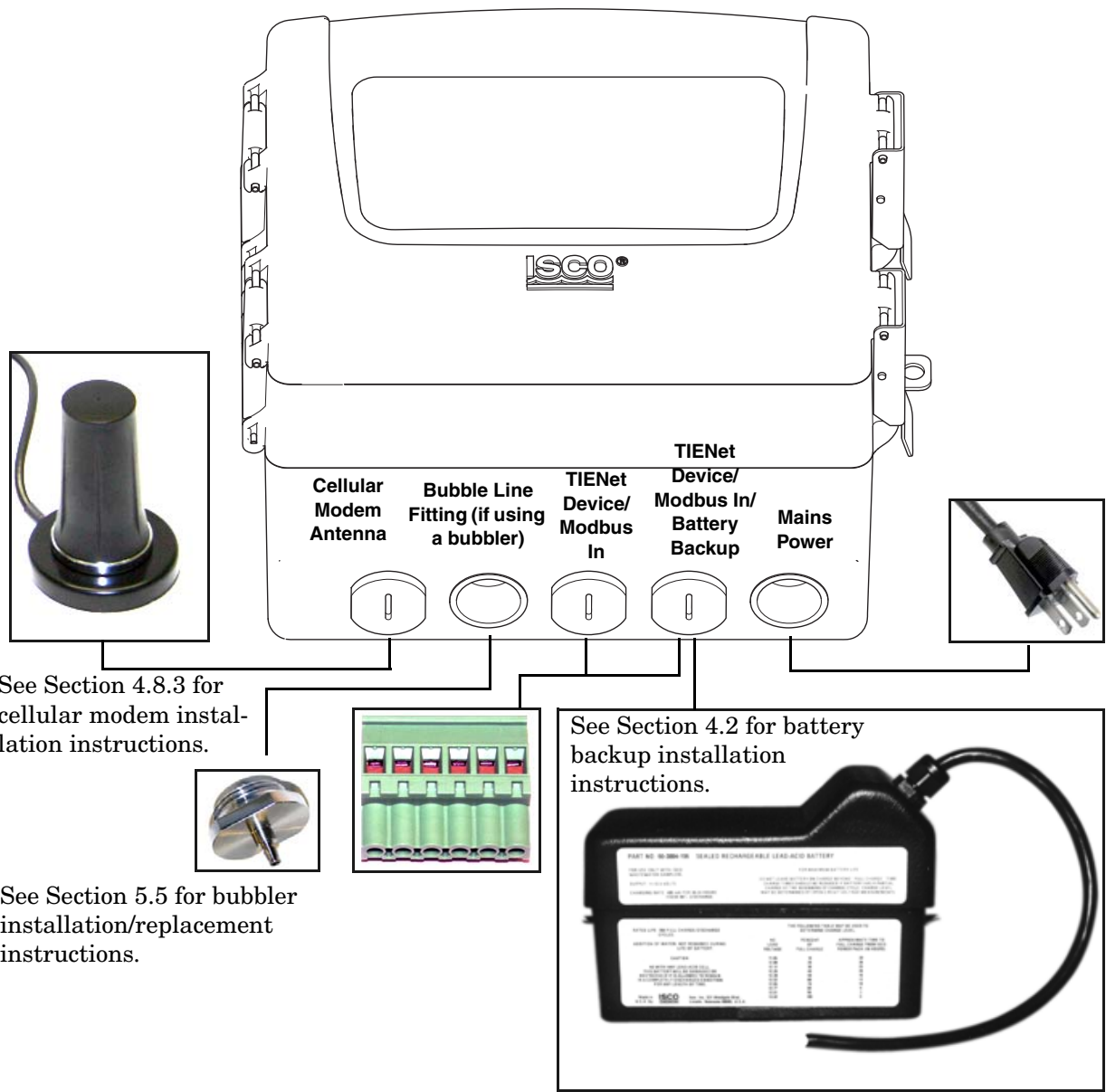

Figure 3-3 Connector Case cable entries for power and external devices

3.2.1 Cable Fittings

Cord-grip fittings for TIENet devices, line cord, and battery backup option are available from Teledyne Isco (see Appendix B for ordering information).

The fitting for the line cord is a special strain-relief fitting, as shown in Figure 3-5.



Figure 3-4 Strain relief 3/4 NPT Cord-grip fitting for TIENet devices



Figure 3-5 Cord-grip fittings installed

Any unused cable entry holes should be sealed with plugs. Do not overtighten the plugs. When a plug is flush against the outside of the case and held in place by the metal nut inside, the hole is sealed.

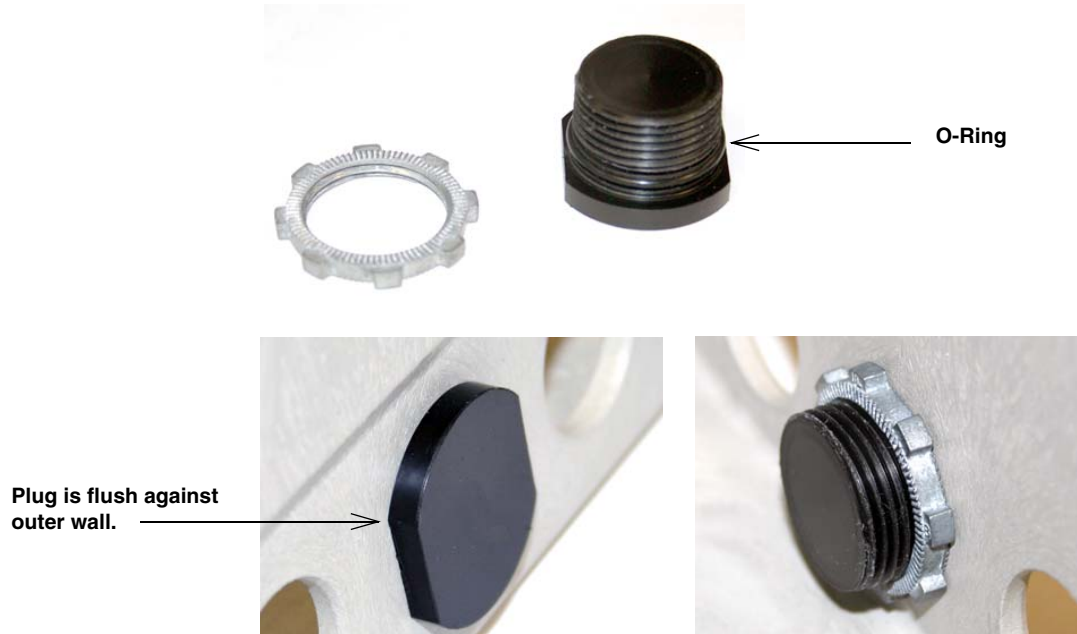

Figure 3-6 Diameter-seal plugs for unused ports

3.3 Connecting TIENet Devices

The optional external TIENet devices compatible with the Signature flow meter all connect in the same manner. Multiple TIENet devices can be connected simultaneously to the same Signature Flow Meter.

Note

The steps that follow include instructions for installing cord-grip fittings. Some applications will use user-supplied $\frac{3}{4}$ " ID conduit for cable routing.

1. Remove one of the 6-position plug-in terminal strip connectors from the connector case.

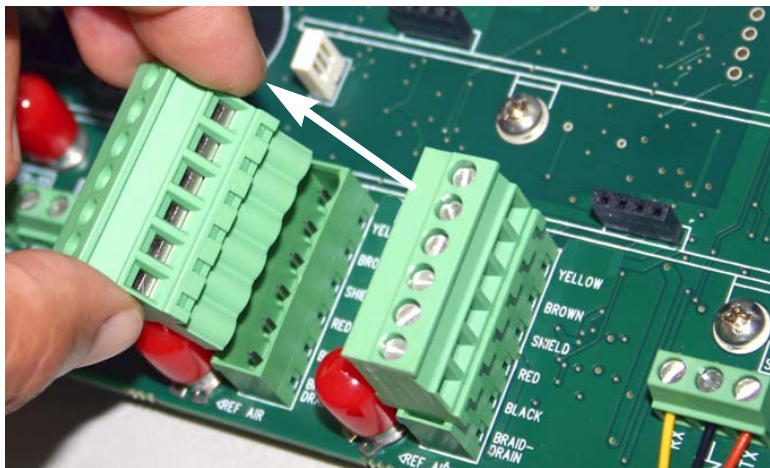

Figure 3-7 TIENet Device terminal strips

2. If using a cord-grip fitting, install the cable nut in the appropriate opening on the bottom of the Signature enclosure, securing it to the wall with the lock nut (concave side facing wall).

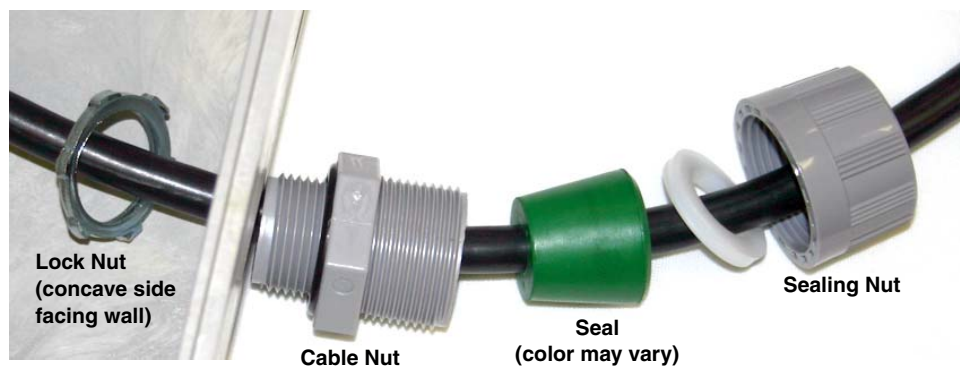

Figure 3-8 Installing TIENet cable with a cord-grip fitting

3. Feed the TIENet device cable end through the sealing nut and seal, and through the cable nut. Lightly tighten the sealing nut, just enough to hold the cable in place while installing the connector.
4. Attach the wire ends to a TIENet connector, then plug the connector into its mating socket, as shown in Figure 3-10. Gently tug each wire when finished, to verify secure connection to the screw terminals.

✓ Note

The *shield* wire is the bare braid emerging from the foil with the yellow and brown wires. The *drain* wire is the bare braid emerging from the wire mesh inside the cable jacket. It is not necessary to prevent the two braids from coming into contact with each other.

5. Press the terminal strip back down into its socket on the connector case, as shown in Figure 3-11, taking care not to strain any wire connections.
6. Gently pull the cable, to remove any slack within the enclosure, taking care not to put any stress on the connection.
7. Tighten the cord grip sealing nut.

⚠ CAUTION

If you are using conduit instead of the cord-grip fitting, the conduit and wires inside must be sealed to prevent harmful gases and moisture from entering the Signature enclosure. Failure to seal conduit could reduce equipment life.

8. Close the front panel and fasten it shut with the two Philips screws.

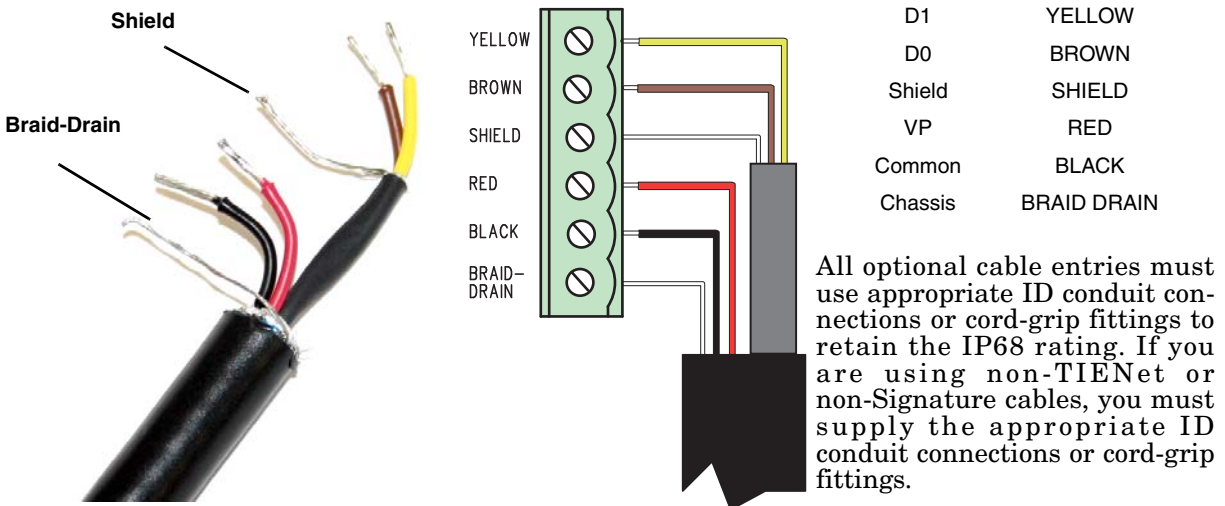

Figure 3-9 TIENet Device terminal connections



Figure 3-10 Attach wired terminal strip to connector case socket

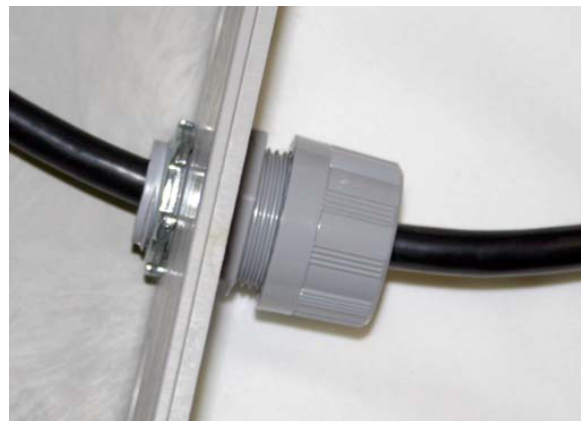
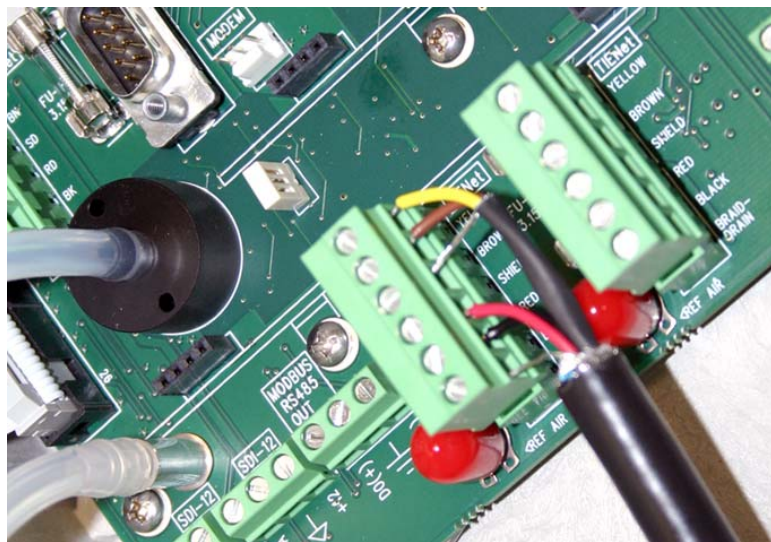

Figure 3-11 Position and secure the cable

3.4 Power

The Signature is in compliance with North American and International safety standards while the input voltage remains within 100-240VAC (50/60Hz).

AC line wiring to the Signature power supply should use twisted pair cabling for optimal electromagnetic compatibility (EMC) with the surrounding environment.

External current protection between mains power and the flow meter must allow for up to 40A inrush current at power up.

If the instrument has been fitted with a line cord, ensure that its installation is near a mains outlet for easy access to remove power in the event of an emergency.

If the instrument has been hard-wired for power using conduit, ensure that a switch or mains circuit breaker is installed near the instrument for easy access to remove power in the event of an emergency.

3.4.1 Connecting Mains Power

The flow meter comes with the power supply wired to the connector case, and held in place by a screw (see Figure 3-12 below).

Mains power is wired into the Signature's internal power supply, normally via a standard three-wire line cord.

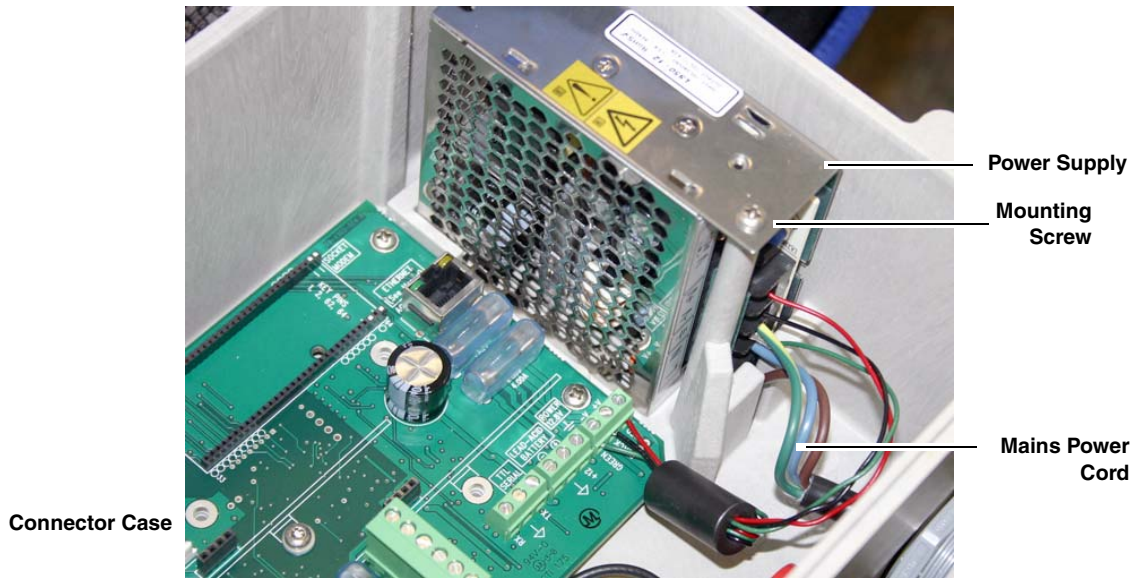

Figure 3-12 Location of power supply

Teledyne Isco offers an AC line cord kit that is installed at the factory when ordered with the Signature. It is also sold separately, and is easily installed by the user.

For installation instructions, refer to Section 4.1 *AC Power Cord Kit*. Note that these instructions can also be used as guidance for installing a user-supplied line cord.

3.5 Mounting the Signature

The Signature can lie flat on a horizontal surface, or be attached to a wall using the stainless steel bracket on the back of the case.

It can also be installed inside a console enclosure with other system components. If a console enclosure is used, ensure that it provided proper sealing to protect the flow meter and other equipment from harsh environments and/or moisture.

Because it uses a bubble line, the Signature does not have to be mounted directly above the primary device, or even particularly close to the flow stream. You will need to mount the unit within 25 feet (7.6 m), or 50 feet (15.3 m) if you are using the 100 foot bubble line. Distances greater than 100 feet are not recommended.

The mounting location should allow for easy removal and reinstallation in the event that cleaning, testing, or replacement is required.

Refer to the dimensional drawings on the following pages for physical installation specifications.



Figure 3-13 Signature Flow Meter mounted on wall

3.6 Outdoor Recommendations

Where the Signature Flow Meter is mounted outdoors, a panel shield for protection from direct sunlight and rain is recommended. The shield should accommodate the flow meter's dimensions of 8.88 x 12.22 x 8.22 inches.

USABlueBook's Model 49474 fiberglass shield, for example, has been used in this type of application.



Figure 3-14 Panel shield - recommended for outdoor installations

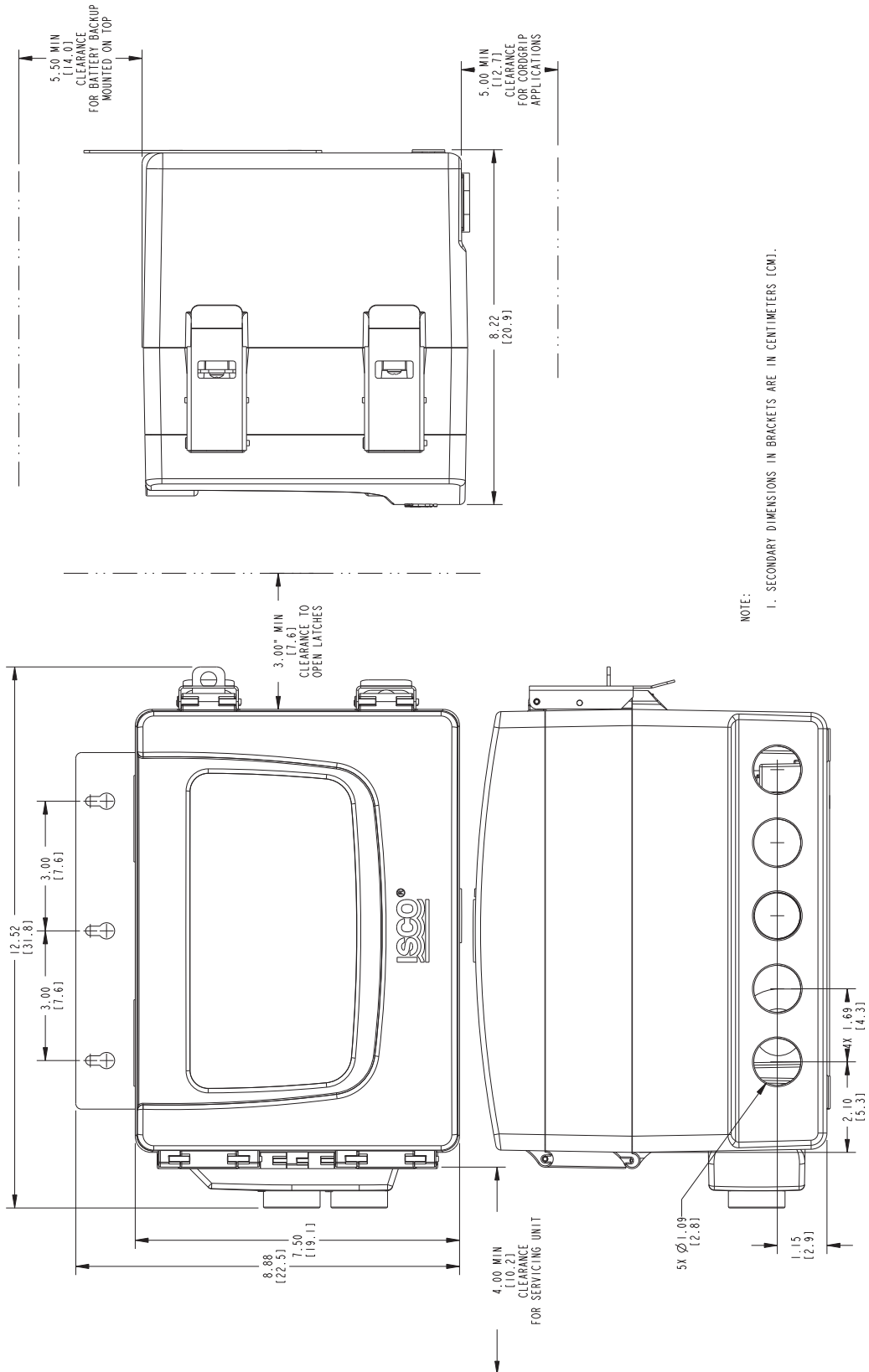

NOTE:
1. SECONDARY DIMENSIONS IN BRACKETS ARE IN CENTIMETERS (CM).

Figure 3-15 Specification drawing: Signature Bubbler Flow Meter, 1 of 2

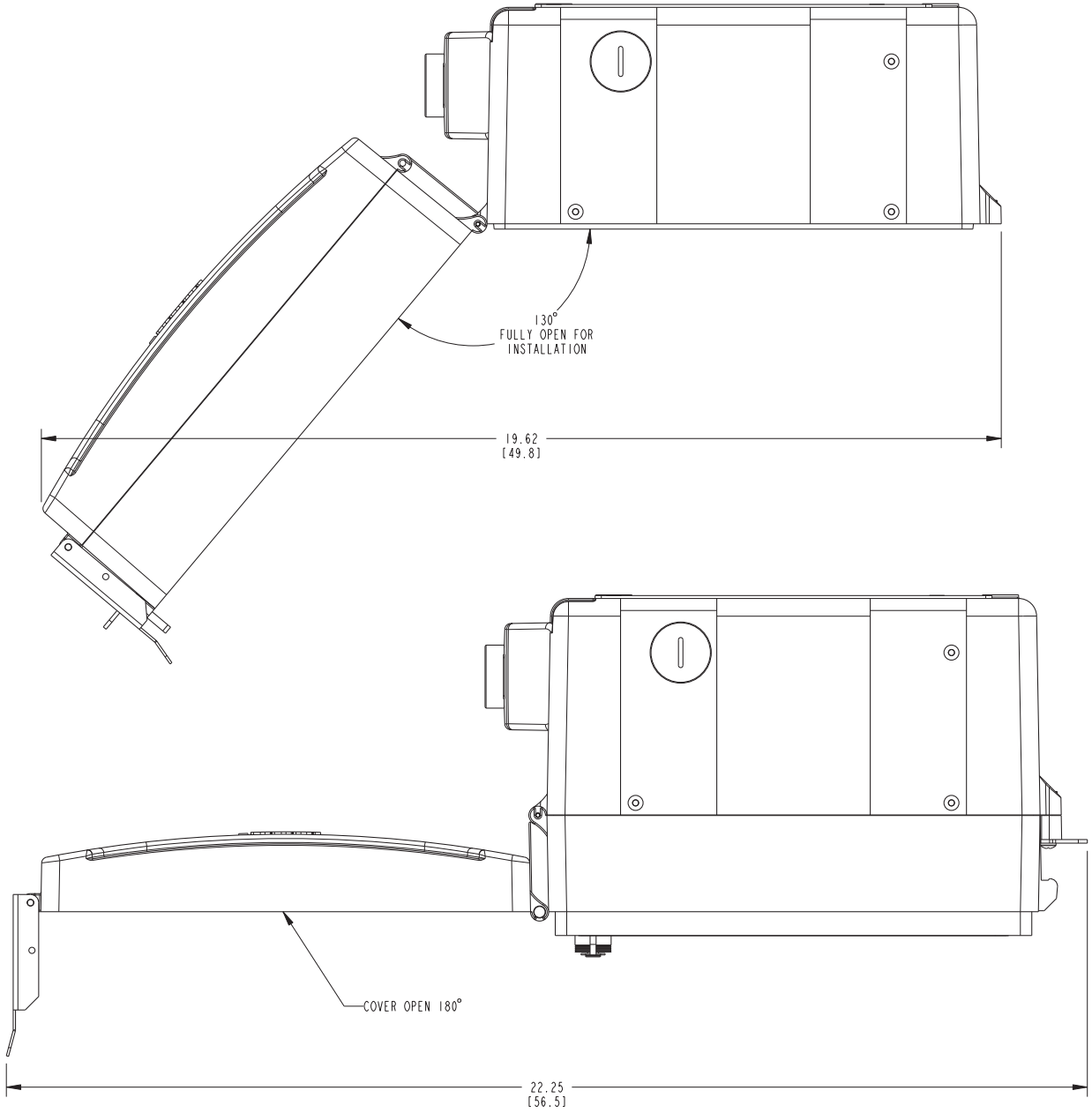

Figure 3-16 Specification drawing: Signature Bubbler Flow Meter, 2 of 2

3.7 The Bubble Line

Anchor the bubble line in the flow stream at the appropriate measuring point in the weir, flume, or other open channel flow situation. Air slowly bubbles out of the line into the flow stream. The pressure in the bubble line is proportional to the liquid level in the flow stream, and the flow meter measures this pressure, sensing the liquid level.

3.7.1 Standard Bubble Lines

Three different bubble lines are available for use with the Signature:

- $\frac{1}{8}$ " (0.32 cm) OD PTFE, $\frac{1}{16}$ " (0.17 cm) ID, 25 ft. (7.6 m) long)
- $\frac{1}{4}$ " (0.63cm) OD vinyl, $\frac{1}{8}$ " (0.32 cm) ID, 50 ft. (15.2 m) long)
- $\frac{1}{4}$ " (0.63 cm) OD vinyl, $\frac{1}{8}$ " (0.32 cm) ID, 100 ft. (30.5 m) long)

3.7.2 Comparing Vinyl and PTFE Bubble Lines

Wherever practical, Teledyne Isco recommends the vinyl line, which offers significant advantages over the PTFE line. The vinyl line has a longer usable length than the PTFE line. This is due to the small inside diameter of the PTFE tubing, which generates an undesirable friction head at lengths greater than 25 feet. Additionally, experience has shown that the larger ID vinyl line is less likely to clog than the PTFE line when used in flow streams with suspended solids. If the distance between the flow meter and the measuring point exceeds 25 feet, you *must* use the vinyl bubble line.

However, for certain installations, the smaller ID PTFE line also has advantages. Due to the small inside diameter, the air volume necessary (and, as a result, battery power) is minimized, a definite advantage for battery-powered installations. Additionally, almost no chemical can attack the PTFE line. Consequently, if power consumption is critical, or there are known agents in the flow stream that might attack the vinyl line, the PTFE line may be more suitable.

3.7.3 Bubble Line Length

The bubble line should be kept as short as possible. This will minimize friction head effects in the line and will also minimize the amount of line exposed to cuts, kinks, etc. Shorten the line as necessary by cutting the tubing with a sharp knife.

Long Bubble Lines – For certain applications, you may need to use a bubble line with an inside diameter larger than that of the standard lines (for example, where the bubble line exceeds 50 feet, or where the flow stream is extremely dirty and the end of the line might clog).

Consult the factory for specific recommendations regarding size of line, special connectors required, etc. In no case should the inside diameter of the bubble line exceed $\frac{1}{4}$ " (0.64 cm), and you should recognize that a larger bubble line will result in increased power consumption, a concern if you must power the flow meter by battery.

3.7.4 Attaching the PTFE Bubble Line

The PTFE bubble line attaches to the flow meter with the bubble line fitting on the bottom of the case and the silicone rubber tubing connector. The tubing connector is a short length of 0.109 inch (0.20 cm) ID, 0.192 inch (0.49 cm) OD silicone tubing attached to a barbed fitting on the case.

The 1/8" OD bubble line simply slips inside the silicone tubing, forming a reliable union you can join and separate without tools.

Attachment

To attach the PTFE bubble line, first slip the 2 inch (5.1 cm) length of 1/4" (0.63 cm) ID vinyl tube included in the instrument accessory package over the end of the bubble line. Grasp the silicone tube to stiffen it and insert the end of the bubble line into the silicone tube.

Slip the short length of vinyl tube over the union and force it over the shoulder of the barbed fitting. The purpose of the short length of vinyl tube is to support the union, preventing fatigue or kinking of the silicone tube.

Removal

To remove the bubble line from the tubing connector, first pull the vinyl tube off of the barbed fitting and slip it down the bubble line. Grasp the end of the silicone tube and then pull the bubble line straight out of the silicone tube.

Several replacement lengths of the silicone tubing are included in the instrument accessory package. Install them on the unit by simply forcing the end of the tube over the barbed connector.

 Note

Avoid placing tension on the silicone tube where it attaches to the barbed fitting. Direct the PTFE tube straight away from the fitting rather than at an angle. This reduces the likelihood of tubing wear and leakage around the fitting.

3.7.5 Attaching the Vinyl Bubble Line

The vinyl bubble line attaches directly to the barbed fitting. Remove the silicone tube and slip the 1/8" (0.32 cm) tubing over the fitting.

3.7.6 Installing the Bubble Line

Install the bubble line at the recommended level measuring point in the primary device or other open channel flow situation. If you do not know where this is, consult the manufacturer of the primary device.

If you are not using a fabricated device, consult the *Isco Open Channel Flow Measurement Handbook* for suggestions. Many different devices are discussed there. Proper location of the bubble line outlet is necessary for accurate measurement. Normally, the bubble line is positioned in the flow stream with the end at a right angle to the flow.

In many installations, it is not practical to locate the outlet of the bubble line precisely at "zero" liquid level. Depending on the situation, the outlet end of the bubble line may be located anywhere within ten feet (3 m) above or below the actual zero level of the primary device. Then calibrate the displayed level using Adjust Options from the Configure menu. Refer to Section 3.8 *Level Calibration*.

Note

The Signature cannot accurately measure liquid levels that are even with or below the bubble line outlet. If you need to measure the liquid level down to the actual “zero” level of the primary device, Teledyne Isco recommends placing the bubble line outlet at least 1 to 2 inches (2.5 to 5.1 cm) **below** the primary device zero level to avoid measurement failures when the liquid level is even with the outlet. Since the flow meter can display negative measurements, you can compensate when you set the level in the flow meter.

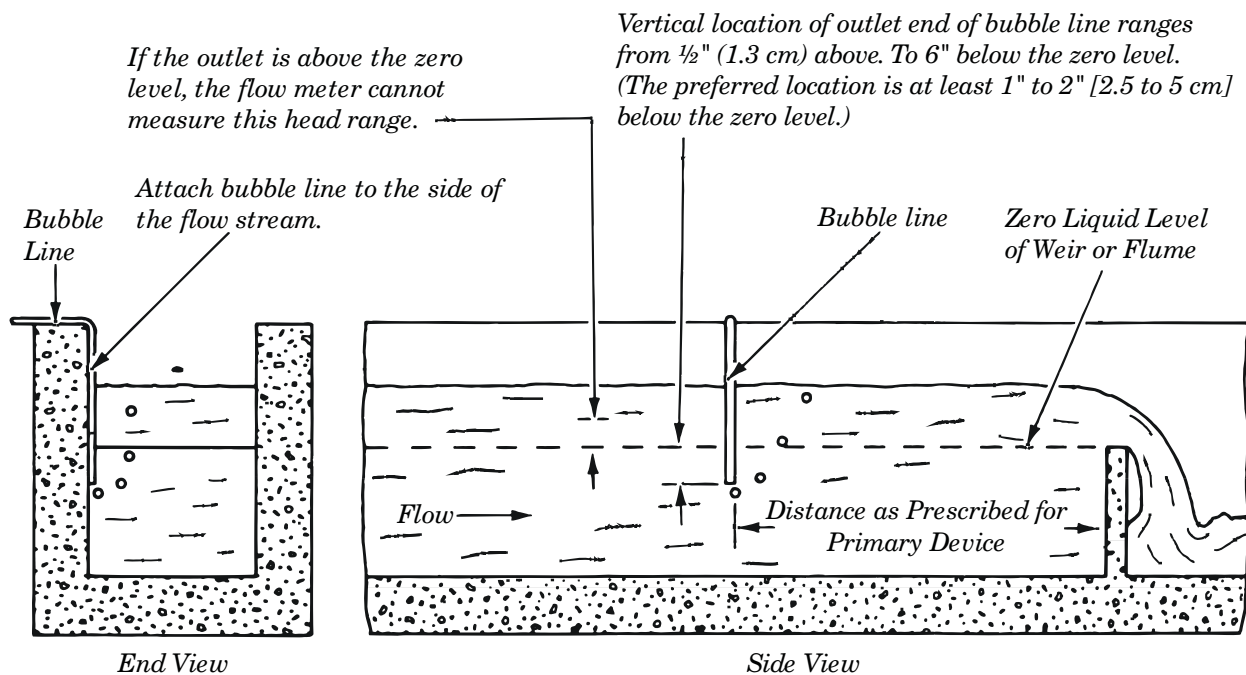

Figure 3-17 Positioning the Bubble Line in the Flow Stream

3.7.7 High-Velocity Flow Streams

The normal position of the bubble line in the flow stream is at a right angle to the flow. However, studies have indicated that at relatively high flow stream velocities (greater than five feet per second [1.5 meters per second]), this location may lead to a measured level lower than actual. This negative level offset is due to localized areas of low pressure near the bubble line outlet; the size of the offset depends upon the velocity of the flow stream and the configuration of the flow stream channel. You can, of course, adjust the level at the flow meter to compensate for the error. However, this is only effective if the flow rate and velocity are essentially constant. If the flow rate drops and the velocity decreases, the level adjustment you made earlier will be incorrect for the new, lower velocity and flow rate.

The best way to overcome this problem is to completely isolate the bubble line from the flow stream velocity by placing it in a stilling well, as described below. If this is not possible, you can perhaps create a cavity in the bottom of the channel, and locate the outlet of the bubble line in the depression, again isolating it from the flow stream velocity.

In flow streams carrying large amounts of solids, however, this may cause problems because of silt collecting in the depression and restricting the bubble line. A third alternative is to put a 90 degree bend in the end of the bubble line, forming a horizontal leg approximately two inches (5 cm) long, and orienting this horizontal leg downstream, parallel with the flow. Tests have shown that this orientation of the bubble line minimizes the effect of flow stream velocity.

3.7.8 Stilling Wells

If the installation includes a stilling well in the primary measuring device, installing the bubble line in the stilling well is recommended. Attach the line securely to the stilling well, using stainless steel and/or plastic mounting hardware.

Not all stilling wells are suitable for bubble line installation. If the well is subject to silting or buildup of foreign material, the bubble line may have to be mounted in the flow stream proper.

3.7.9 Flume Bubble Line Fittings

The large variety of primary measuring devices and installations makes comprehensive bubble line installation instructions impractical. However, valid general observations on bubble line installation can be made. Flumes can be specified to include a bubbler fitting. In new construction, this is highly recommended. It may even be possible to modify an existing installation to include a permanent bubbler fitting.

3.7.10 Bubble Line Extensions

Teledyne Isco offers both stainless steel and copper bubble line extensions. The metal extension may be easier to install in the flow stream than the plastic bubble line because of its rigidity. Two different extensions are available to match the two standard bubble lines.

The extension for the PTFE bubble line includes a silicone rubber tubing connector, and the tubing installation is as described above. The vinyl bubble line attaches by simply slipping the vinyl tube over the end of the extension.

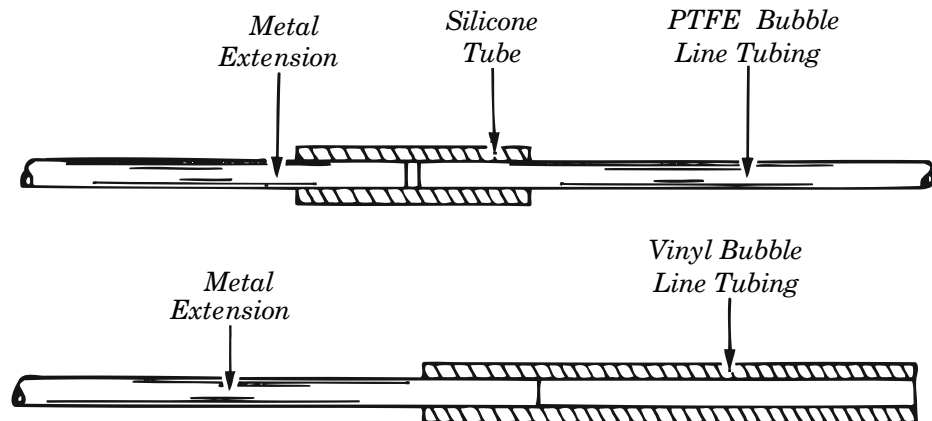

Figure 3-18 Installing the Stainless Steel Bubble Line Extension

3.7.11 Open Channel Installation

If you do not use a stilling well, attach the bubble line to the side of the flow channel or flume. Make the attachment so it causes a minimum amount of disturbance to the flow stream. If possible, cut a groove in the side of the channel, place the bubble line in the groove, and then grout over the groove.

Alternatively, you can attach the bubble line to the side of the channel, and then grout over the line to form smooth, sloped lead-in and lead-out surfaces. However, if neither of these methods is practical, you may simply attach the bubble line to the side of the channel or the upstream side of a weir using stainless steel and/or plastic mounting hardware.

In any case, always install the bubble line so it causes as little disturbance to the flow stream as possible. This usually means an installation on or adjacent to a channel wall where there is a condition of stagnant flow. For temporary survey applications, you can attach the bubble line with waterproof tape or other temporary means.

3.8 Level Calibration

Although all other programming steps can be performed off-site, the liquid level must be set at the measurement site following installation.

Once the 330 bubble line is installed in the flow stream, or the 310 sensor is installed over the flow stream, measure the present liquid level and enter this value for Level, under Configure > Adjust Options. Then highlight “Adjust” and press Enter to confirm.

From this screen, you can also update the display to show the current level of the stream.

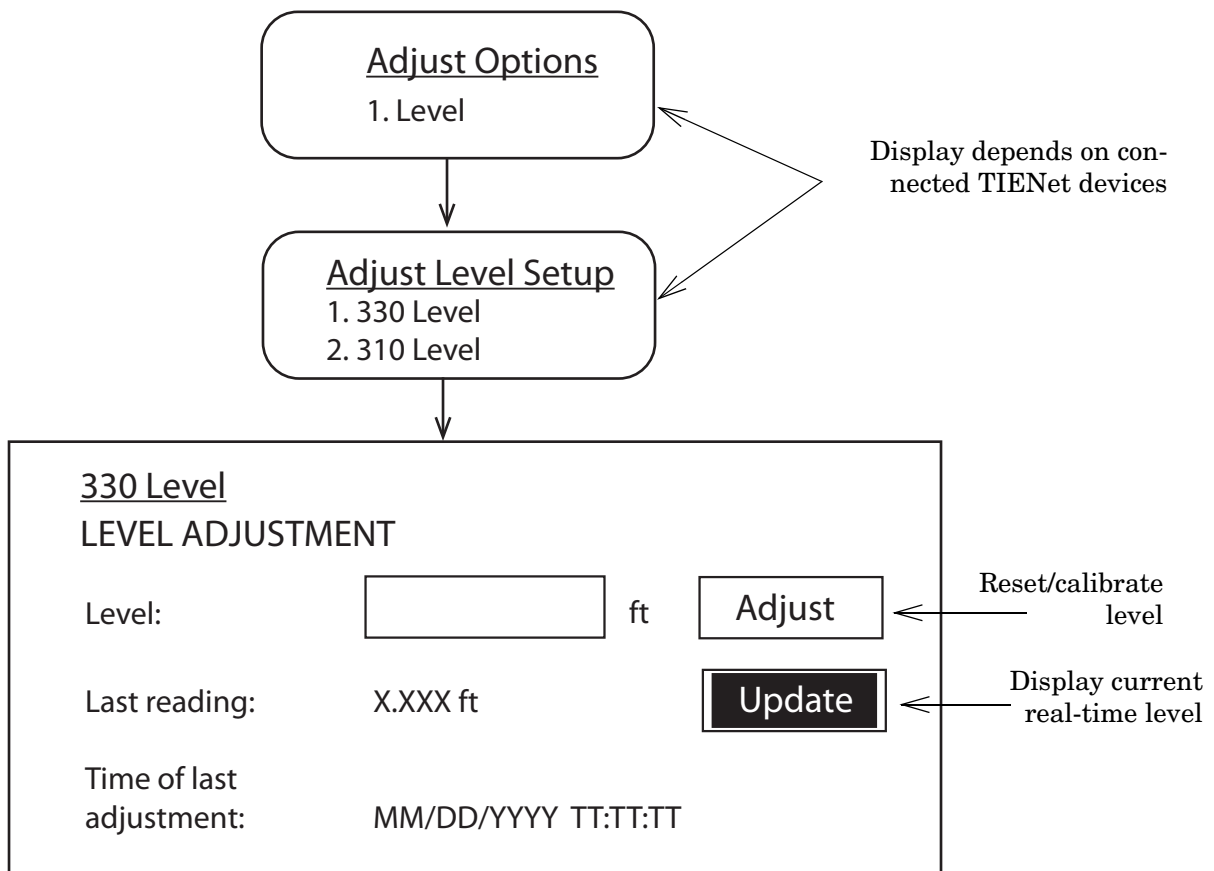

Figure 3-19 Level adjustment and calibration

Signature™ Flow Meter

Section 4 Equipment Options

Optional equipment is designed to be user-installable. Internal options, when ordered at time of purchase, are installed in the Signature meter at the factory. This section describes each option and provides instructions for its installation and operation.

All optional cable entries must use appropriate ID conduit connections or cord-grip fittings to retain the IP68 rating. If you are using non-TIENet or non-Signature cables, you must supply the appropriate ID conduit connections or cord-grip fittings.

Note

Installation and operation of exterior TIENet devices is covered in detail in the user manual for that technology.

Most options require interior access for installation. For connector case interior access and TIENet device wiring instructions, refer to *Accessing the Interior*, on page 3-1 and *Connecting TIENet Devices*, on page 3-7.

DANGER

Before opening the case, first ensure that mains power is disconnected from the unit.

CAUTION

Before opening the case, disconnect the optional battery backup power, if used.

Part numbers for ordering accessories are provided in Appendix B *Options and Accessories*.

Optional equipment from Teledyne Isco includes:

AC Power Cord Kit, on page 4-2

Battery Backup, on page 4-4

Mechanical Totalizer, on page 4-6

Ultrasonic Level Sensor, on page 4-10

Bubbler Level Sensor, on page 4-10

Sampler Interface, on page 4-10

pH and Temperature Device, on page 4-10

TIENet Expansion Box, on page 4-11

Analog Current Output, on page 4-12

Reference Port Tubing Kit, on page 4-16

Isco Flowlink Software, on page 4-18

Ethernet Modem, on page 4-18

Cellular Modems, on page 4-23

4.1 AC Power Cord Kit

The AC power cord kit includes a line cord with a strain relief cord-grip fitting. If ordered with the Signature Flow Meter, it will be shipped from the factory already installed.

Instructions for user installation are provided in this section, and can also be used for installation of user-supplied line cords.

Note

The steps that follow include instructions for installing cord-grip fittings. Some applications will use user-supplied $\frac{3}{4}$ " ID conduit for cable routing.

1. Remove the mounting screw and lift the power supply out of its molded niche, taking care not to strain the wires going to the board.
2. For access to the terminals on the power supply, remove the clear plastic shield protecting them (Figure 4-2). The Signature ground wire ends in a ring terminal so that the line cord ground wire can easily be connected to the same terminal.
3. Remove the lock nut from the cable nut.
4. Install the cable nut through the line cord cable entry (closest to power supply location) in the bottom of the connector case and secure it to the Signature case wall with the lock nut.
5. Feed the line cord end through the sealing nut and then through the cable nut, into the case.

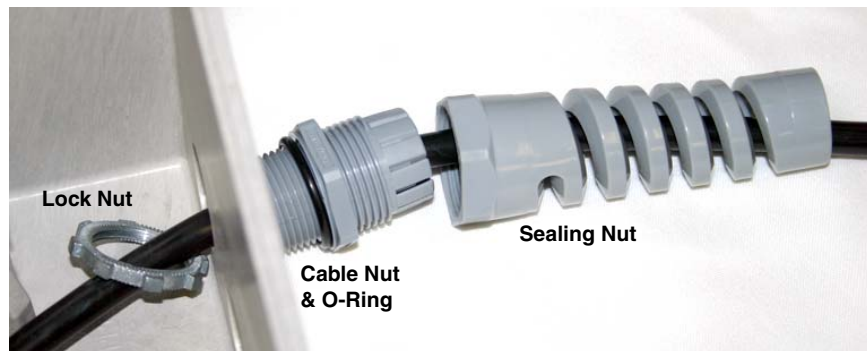

Figure 4-1 Installing AC line cord with a cord-grip fitting

6. Lightly tighten the sealing nut, just enough to hold the line cord in place while connecting it to the power supply.
7. Connect the line cord wires to the power supply, as shown in Figure 4-2, and then reinstall the plastic protective shield.

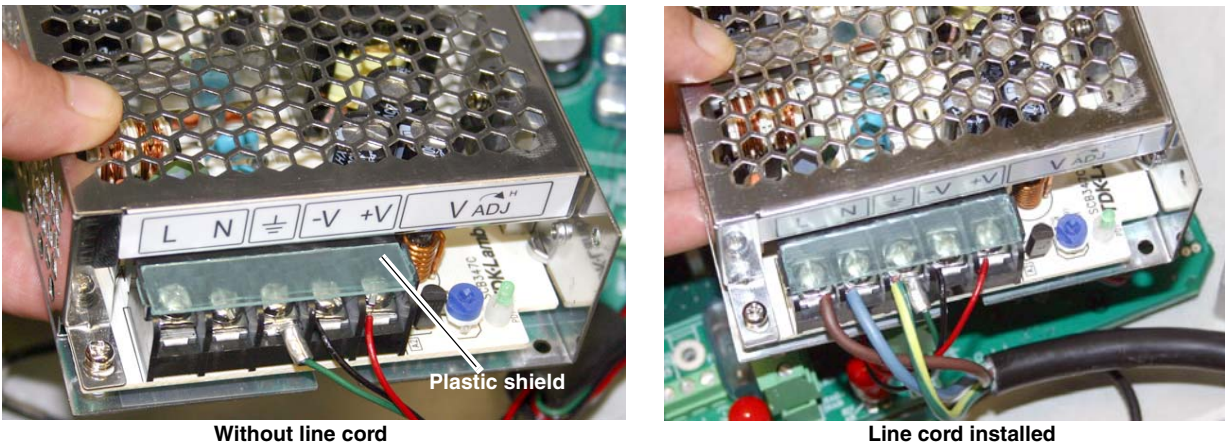

Figure 4-2 Access terminals and connect line cord

8. When seating the power supply into its niche, guide the attached wires around in front of the mounting standoff and through the molded slot, so they are not strained or damaged.

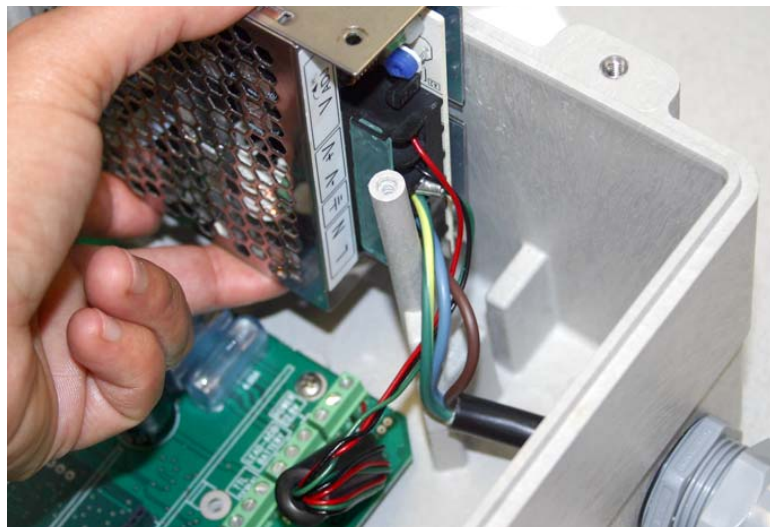

Figure 4-3 Re-seating the power supply

9. Gently tug the line cord to remove any slack within the enclosure, taking care not to stress the connection.
10. Tighten the cord grip sealing nut.

CAUTION

If you are using conduit instead of the cord-grip fitting, the conduit and wires in the conduit must be sealed to prevent harmful gases and moisture from entering the Signature enclosure. Failure to seal conduit could reduce equipment life.

11. Close the front panel and fasten it shut with the two Philips screws.

4.2 Battery Backup

The battery backup option consists of a Teledyne Isco Model 946 lead-acid battery pack and extension cable, with special hardware to mount it on the top of the Signature Flow Meter, or on a wall. The unterminated power cable normally enters the connector case through the second port from the right.

 **DANGER**

Before opening the case, first ensure that mains power is disconnected from the unit.

 **CAUTION**

Before opening the case, disconnect the optional battery backup power, if used.

 **CAUTION**

Do not substitute another battery type for this option. Use only the Model 946 Lead-Acid battery.



Figure 4-4 Battery backup kit contents

 **CAUTION**

If you are using conduit instead of the cord-grip fitting, the conduit and wires must be sealed to prevent harmful gases and moisture from entering the Signature enclosure. Failure to seal conduit could reduce equipment life.

Installation

1. Remove line power from the Signature Flow Meter and open the case as previously described in Section 3.1.

CAUTION

Do not connect the extension cable to the battery cable until all other steps are completed.

2. At the LEAD-ACID BATTERY terminal strip, connect the extension cable's black wire to the +12 terminal, and the white wire to the ground terminal.

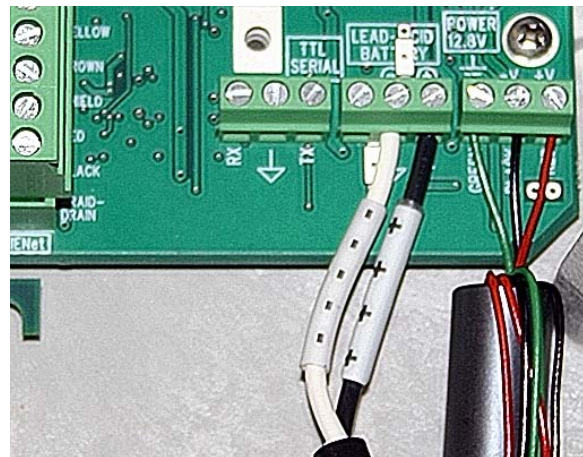

Figure 4-5 Attach extension cable to the connector case

3. Install the mounting plate, either on top of the flow meter case using the Torx screws provided, or on the wall nearby.

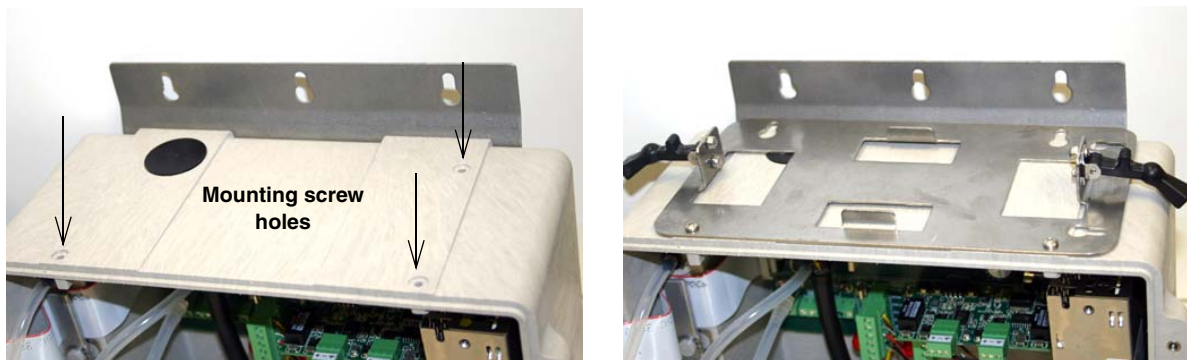

Figure 4-6 Installing the battery backup mounting plate

4. Place the 946 battery on the mounting plate and secure it in place using the two black rubber draw catches.
5. Connect the battery cable to the extension cable.



Figure 4-7 Backup battery, installed



Note

Be sure to unplug the battery when intentionally disconnecting from AC power.

4.3 Mechanical Totalizer

The mechanical totalizer is a seven-digit, non-resettable mechanical counter installed in the front panel. It increments according to programmed totalizer resolution and units of measure.

The volume represented by the mechanical totalizer is always the primary Total Flow programmed in Measurement Setup > Volume Input Setup (refer to *Configure*, on page 2-17).

The mechanical totalizer increments with the **third significant digit** of the selected resolution (see Figure 2-15 *Menu Tree: Volume Input Setup (total flow)*), e.g.:

- Resolution 999999999 = Increment every 100 units;
- Resolution 99999999.9 = Increment every 10 units;
- Resolution 9999999.99 = Increment every 1 unit, etc.

The Signature permits a maximum 300 counts per minute; if totalized flow exceeds this rate, remaining volume will be buffered until it can be counted, although buffering over extended time periods is not recommended.

Installation

1. Remove line power from the Signature Flow Meter and open the case as previously described in Section 3.1.
2. To ensure that the bubble line tubing is reconnected correctly, label the tubing ends as shown below in Figure 4-8, then remove the four mounting screws holding the 330 bubbler in place and set it aside.

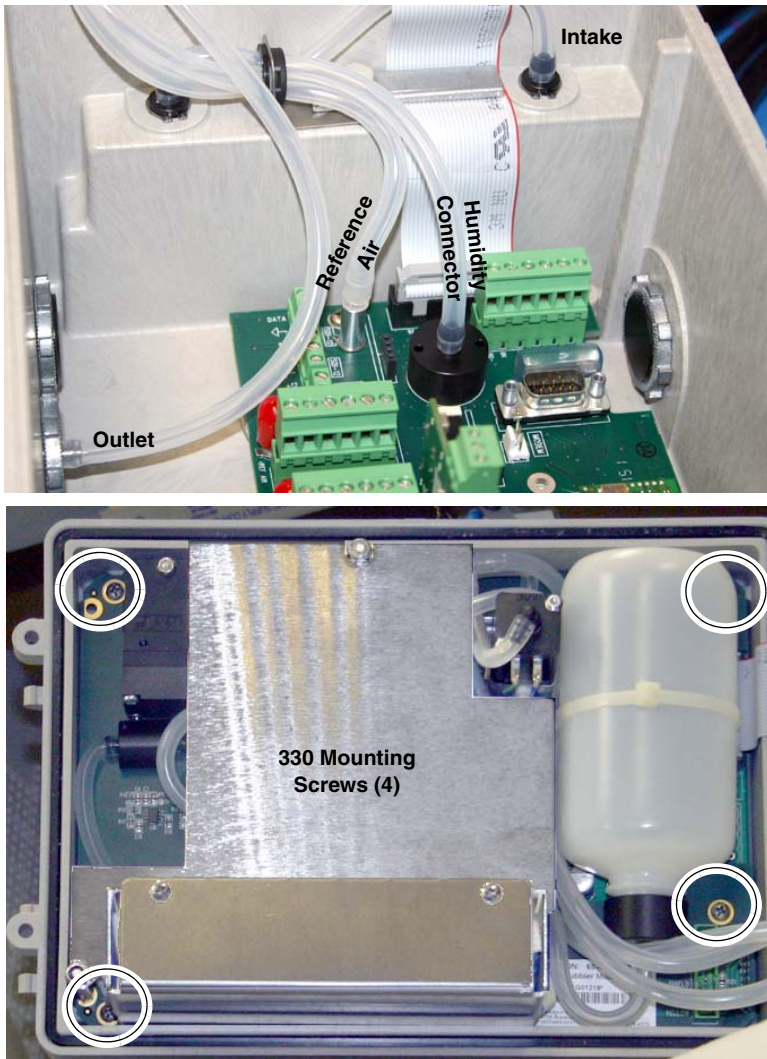

Figure 4-8 Disconnect and remove bubbler module

3. Using a razor blade or utility knife, carefully cut the six tabs in the control panel label to detach the totalizer window cover.

Note

Be sure to cut all six tabs. Pulling on the cover with some of the tabs still attached will damage the control panel label.

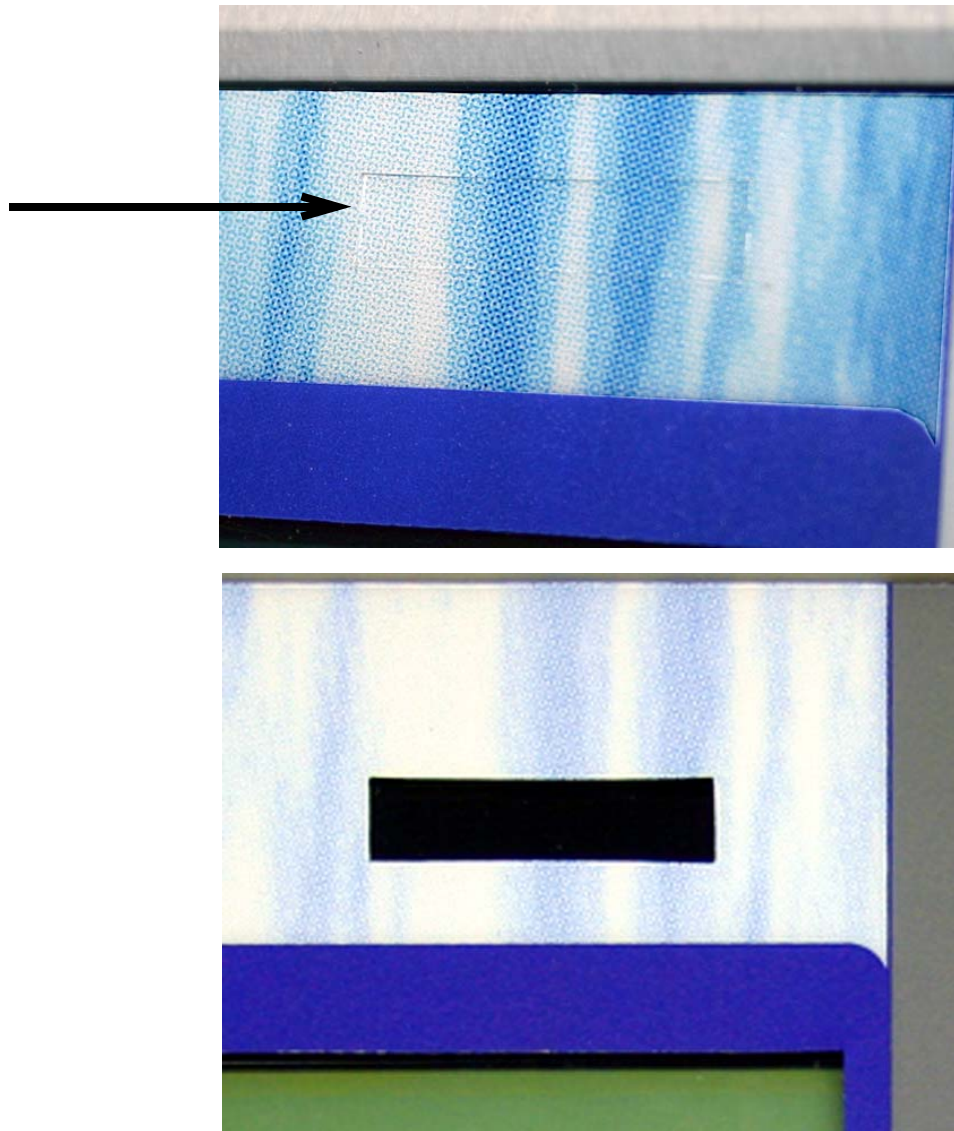

Figure 4-9 Remove totalizer window cover

Referring to Figure 4-10:

4. Remove the two screws above the totalizer cutout provided in the CPU board. These screws will be used for mounting the totalizer.
5. Install the totalizer in the cutout, attaching the two mounting tabs with the two screws, so that the numbers appear in the window.
View the totalizer through the window and adjust the position, if necessary, before tightening the screws.
6. Plug the totalizer connector into **P10** on the CPU board.



Figure 4-10 Optional non-resettable totalizer installation

4.4 TIENet™ Devices

Teledyne Isco's proprietary TIENet connectivity allows for the combination of multiple flow measurement technologies and other devices with the Signature flow meter.

4.4.1 Ultrasonic Level Sensor



The TIENet 310 Ultrasonic Level Sensor mounts directly over the flow stream. The sensor measures level by transmitting an ultrasonic pulse toward the liquid surface and then measuring the time it takes for the echo to return. The 310 is normally used with some type of primary device (typically a weir or flume) to measure flow in an open channel.

For complete installation and operation procedures, refer to the TIENet 310 sensor's user manual, part #69-4313-010.

4.4.2 Bubbler Level Sensor



The factory-installed TIENet 330 Bubbler is normally used with some type of primary device (typically a weir or flume) to measure flow in an open channel.

The amount of pressure required to force bubbles from the end of a submerged bubble line is directly dependent on the hydrostatic pressure of the flow stream over the end of the bubble line. A pressure transducer inside the module senses this pressure and converts it into a level signal that the flow meter uses to calculate flow rate and total flow.

Because the 330 Bubbler is a standard component in bubbler Signature meters, installation instructions are located in Section 5 *Maintenance and Servicing*, under *330 Bubbler Installation*.

4.4.3 Sampler Interface



The TIENet 306 Sampler Interface connects the Signature Flow Meter to a Teledyne Isco wastewater sampler. Through this connection, the Signature can enable the sampler based on user-specified conditions, pace the sampling routine based on flow volume, and receive sample and bottle information from the sampler.

For complete installation and operation procedures, refer to the TIENet 306 device's user manual, part #69-4303-072.

4.4.4 pH and Temperature Device

The TIENet 301 pH sensor measures the acidity or alkalinity of an aqueous solution by determining the relative quantity of dissociated hydrogen ions in the solution. The normal scale for pH runs from 0 to 14, with 0 being most acidic and 14 being the most alkaline.

For complete installation and operation procedures, refer to the TIENet 301 device's user manual, part #69-4303-071.

4.4.5 TIENet Expansion Box

The water-tight expansion box connects to a TIENet terminal strip like other TIENet devices, and contains three additional strips inside, for connecting more devices. Additionally, the expansion box contains a TIENet connection for an option card (such as the 308 Analog Output option, Section 4.4.6).

Note

The expansion box is not rated for use in hazardous locations.

Enclosure Rating:
IP67 (NEMA 4X, 6)

All optional cable entries must use appropriate ID conduit connections or cord-grip fittings to retain the IP67 rating. If you are using non-TIENet or non-Signature cables, you must supply the appropriate ID conduit connections or cord-grip fittings.



TIENet device terminals

Desiccant bag

Option card location

Mounting plate

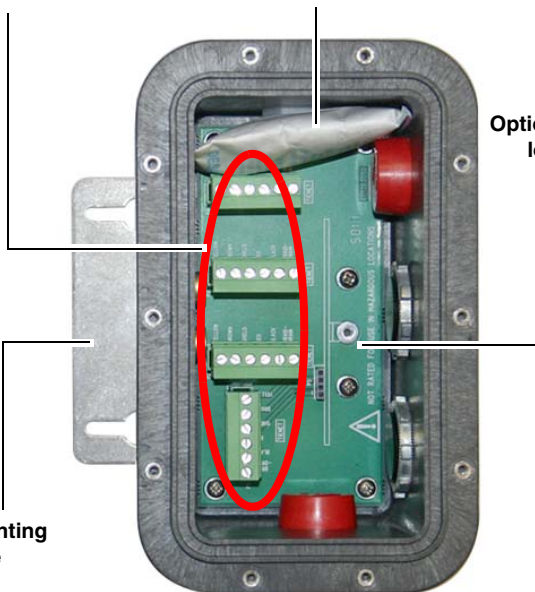

(cord-grip fittings ordered separately)

Figure 4-11 TIENet Expansion box

4.4.6 Analog Current Output

Analog outputs convert digital information from the flow meter to a variable analog output current ranging from 4 to 20 milliamperes. When a condition measured by the flow meter is converted into an analog output, 4 mA becomes the 0%, or baseline, for the condition, while 20 mA becomes the 100%, or full-scale, of the condition. For basic programming steps, refer to Figures 4-14 and 4-15.

The Signature accepts up to three internal, user-installable TIENet 308 option cards, with two scalable 4-20mA outputs apiece, for connection between the Signature meter and non-Isco process control equipment or other equipment that accepts a 4-20mA current signal.

CAUTION

Use proper static dissipation when handling circuit boards.

Programming menus and data display distinguish each output by serial number and channel number.

Tools required

T-15 Torx driver

To install a card:

1. Remove power from the Signature flow meter and open the case, as previously described in *Accessing the Interior*, on page 3-1.
2. The option card includes a mounting screw. Remove the tubing retainer from the screw.
3. Remove the 3-pin header clip from its socket on the board.
4. Connect the receiving wires to the terminals according to their labeling (positive and ground).

Note that Channel 1 and Channel 2 are identified on the back of the board.

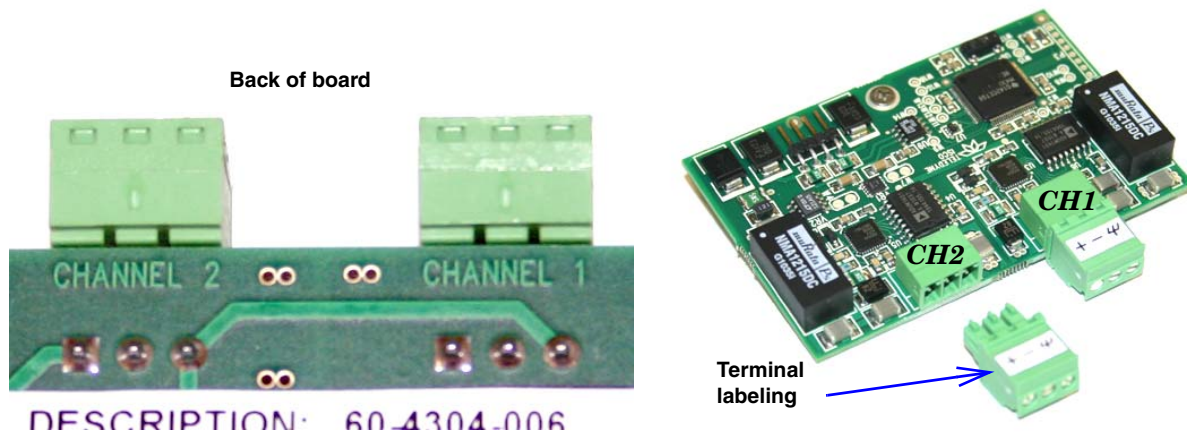
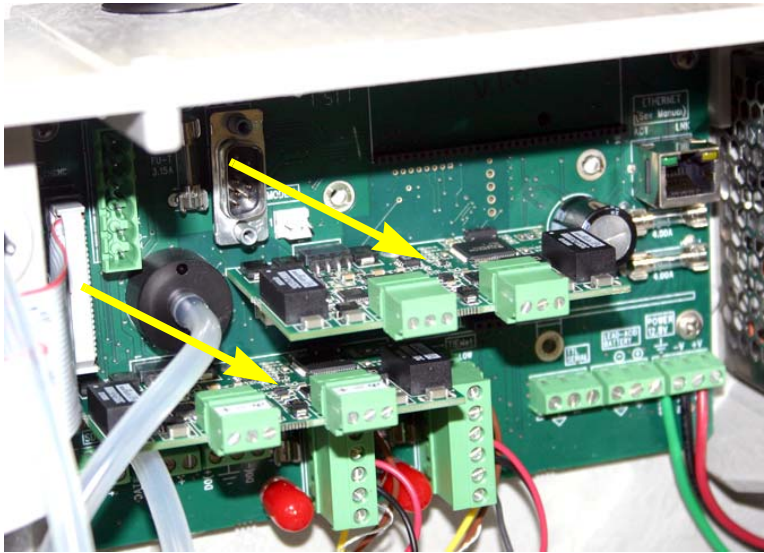

Figure 4-12 Analog output channel identification and terminal connections

5. Gently press the card down so that the 4-pin connector **P4** plugs into one of the three analog output jacks on the board (Item 'J' in Figure 3-2).
6. Secure the card in place by tightening its mounting screw with the T-15 Torx driver. Do not overtighten.



Two 308 cards are shown here. The Signature accepts up to three cards at once, for a possible six simultaneous output channels.

Figure 4-13 TIENet 308 Analog output card installed (two shown)

7. Feed the clip with receiving wires through the appropriate port on the bottom of the meter, and press the clip down into its socket on top of the card.

Note

Cabling is user-supplied. Shielded cable is recommended. For cord-grip fitting options, refer to Appendix B, Section B.2. If conduit is used, the conduit and wiring must be sealed to prevent entry of harmful gases and/or moisture.

Configuration

The 308 measurement configuration screen includes both a current reading in amperes and a scale percentage of the parameter represented.

For basic programming steps, refer to Figures 4-14 and 4-15.

Home display

If only Current is selected under Hardware Setup (see Figure 4-14 on the following page), the analog reading displayed on the Home screen will be in amperes (amps) or milliamperes (mA), whichever you have selected for units of measure (refer to *Site Setup*, on page 2-18). If Percent is selected, regardless of whether or not Current is also selected, the analog reading will be displayed on the Home screen as a Percentage (%).

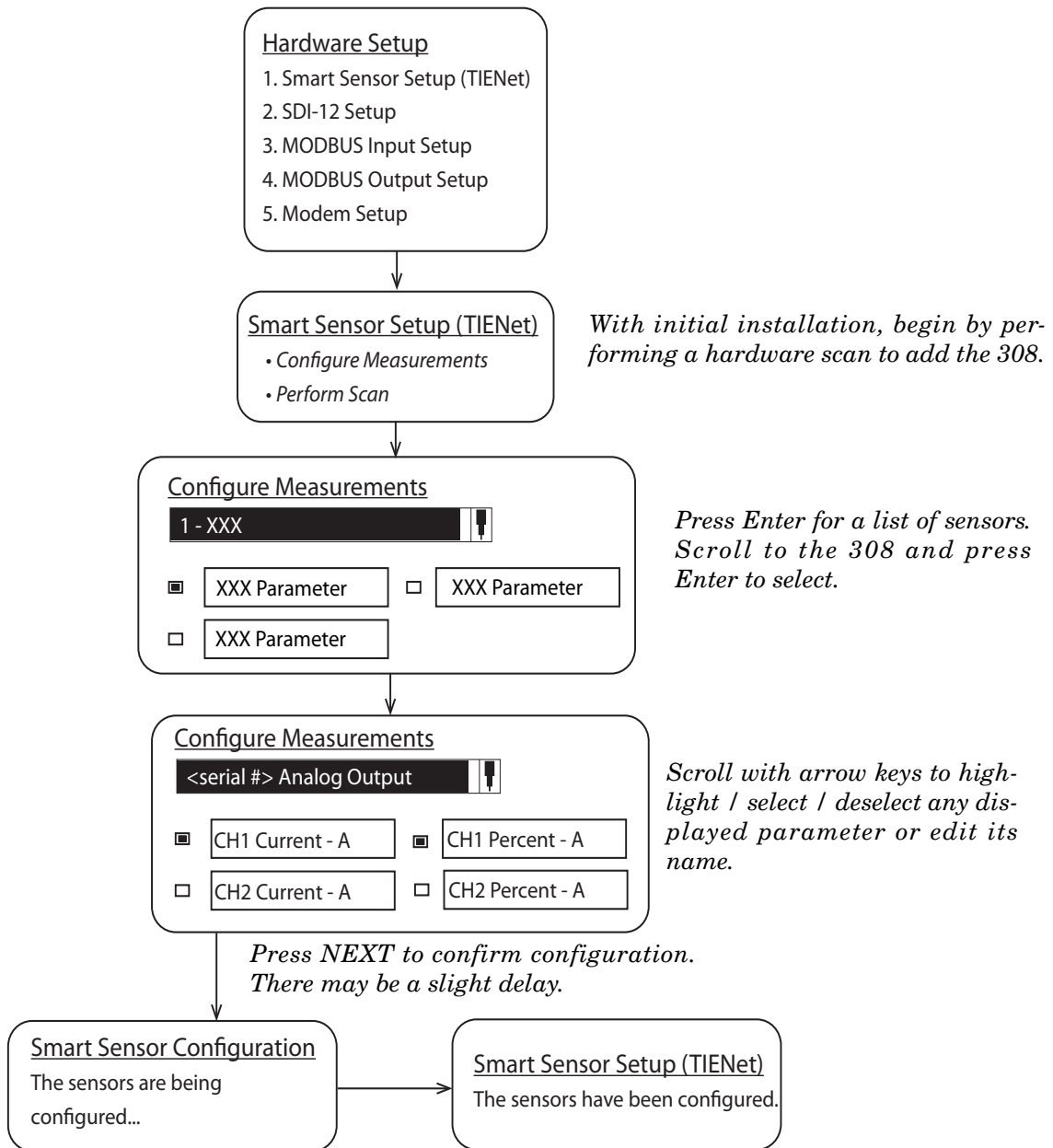

Figure 4-14 308 Device configuration

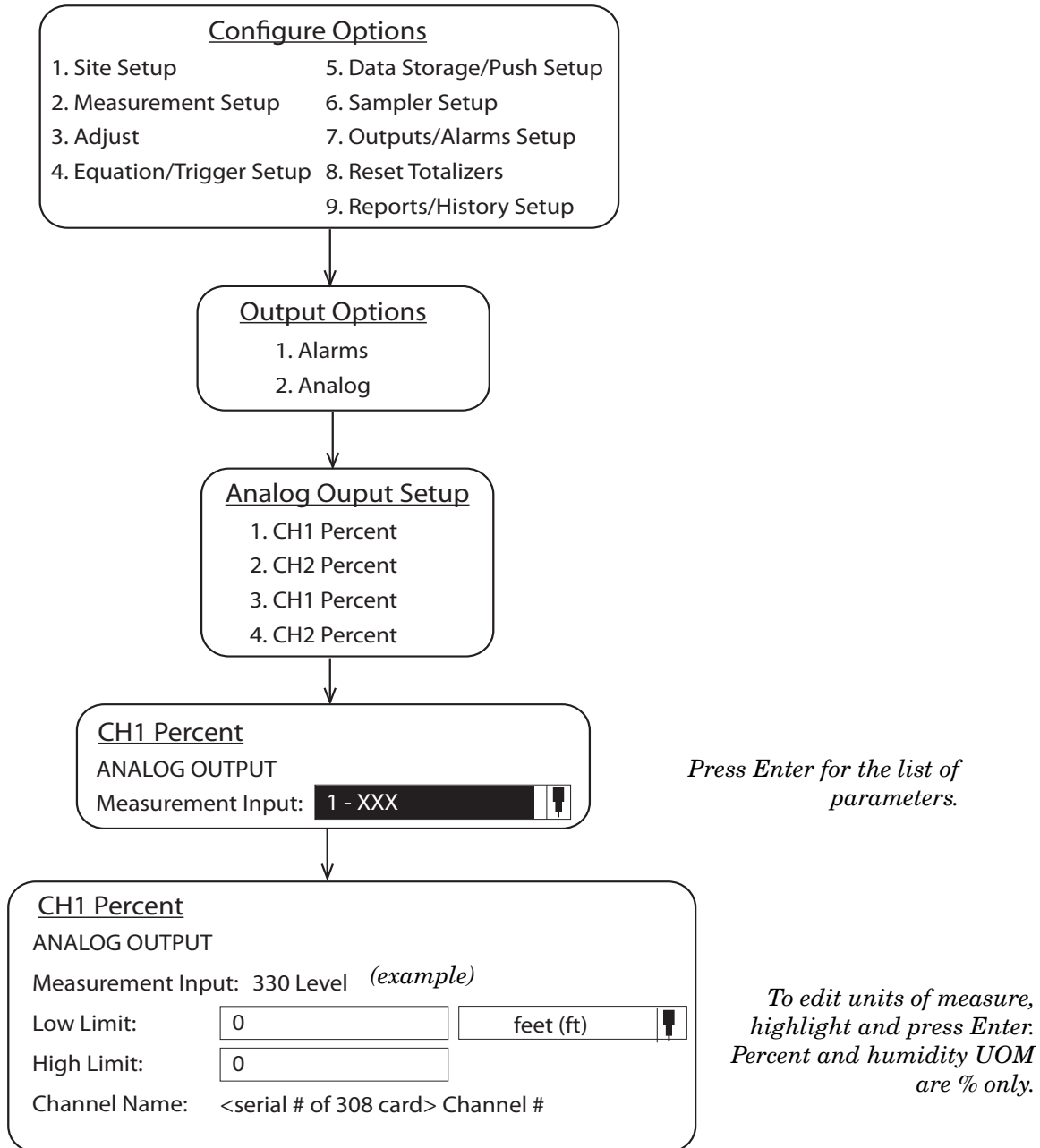

Figure 4-15 Analog output setup

4.5 Reference Port Tubing Kit

For Signature Bubbler monitoring sites where the flow meter mounting location does not provide adequate reference to atmospheric pressure at the measuring point, the reference port tubing kit includes tubing and adaptors to relocate the reference port.

An extra kit can also be used for the bubbler intake, if the air at the flow meter mounting location is excessively humid.

The 25-foot, vinyl $\frac{1}{4}$ " ID, $\frac{3}{8}$ " OD tubing should be cut to the shortest length practical for your installation.



Figure 4-16 Reference port kit (full length not shown)

Installation

The tubing attaches to the reference port of the external desiccator. If using two kits, the second tube attaches in the same manner to the intake port of the external desiccator.

To install:

1. Unscrew the hydrophobic filter cap from the reference chamber (smaller chamber) of the external desiccator.



Figure 4-17 Reference port kit: Remove filter and barb

2. Screw the hydrophobic filter into the end of the reference port tubing connector.
3. Screw the hose barb fitting with o-ring into the reference port of the desiccator.



Figure 4-18 Reference port kit: Install filter and barb

4. Push the open end of the tubing down over the hose barb fitting.



Figure 4-19 Reference port kit: Installed on flow meter

4.6 Isco Flowlink Software

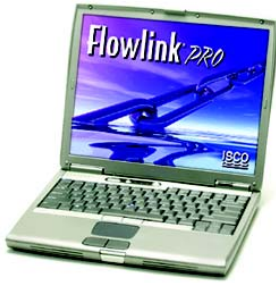

Flowlink® is Teledyne Isco's proprietary software system for data acquisition, storage, retrieval, and analysis. Using the interface of Microsoft Windows, Flowlink can be used to remotely program the Signature Flow Meter, retrieve data from the flow monitoring system, present site data graphically, and generate statistical information from the site data.

Flowlink helps ensure data integrity by displaying the Signature's tracked configuration changes, data measurement summaries, diagnostic test results, and user events in the program. With these tools, Flowlink provides assurance that the data has not been altered.

USB drivers for computer direct connection to the Signature Flow Meter are included on the Flowlink CD, and must be loaded prior to direct connection between the computer and the Signature.

See Section *Connecting to the Signature with Flowlink*, on page 2-2 for instructions on how to connect to the Signature meter with Flowlink software.

From Flowlink, the event data can be exported and saved in the form of text reports on your computer, searchable by site name, module, and date. For complete information, refer to Section *Signature Data in Flowlink*, on page 2-31.

4.7 Ethernet Modem

Setup and data retrieval through the Signature's web browser, as well as alarm outputs, can be accomplished remotely with the ethernet modem, using TCP/IP communication protocol with a static address. The ethernet modem is factory-installed on the connector case.

The ethernet modem is also user-installable. Remove line and/or optional battery power from the Signature Flow Meter and open the case as previously described in Section 3.1.

 **CAUTION**

Always use proper static dissipation methods when handling circuit boards.

 **DANGER**

Before opening the case, first ensure that mains power is disconnected from the unit.

 **CAUTION**

Before opening the case, disconnect the optional battery backup power, if used.



Figure 4-20 Ethernet modem kit contents

1. Press the modem assembly down into its socket on the connector case (item G in Figure 3-2 *Connector case, connectors, and fuses*), with the row of dots along the bottom left and right edges aligned with the row of circles on the board to ensure proper orientation.

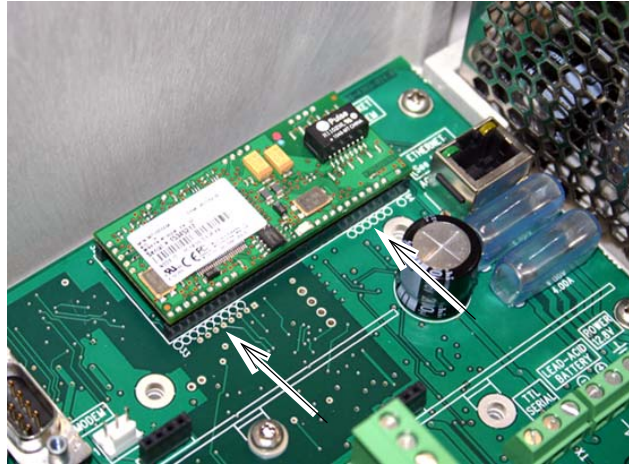

2. Place the plastic spacer over the screw hole by the bottom right corner of the modem.
3. Place the lock washer on top of the spacer.



4. Place the rectangular retainer over the lockwasher, with the counter-sink facing up, and attach with the screw.



Figure 4-21 Ethernet modem installation

In order to communicate with the Signature Flow Meter using the ethernet modem, your network must have TCP/IP services installed. A static IP address must be reserved for the Signature, and client network computers must be allowed to access the static IP address.

4.7.1 Ethernet Modem Configuration

When installation is complete and power restored, wait one minute for the Signature to recognize the modem before programming.

When you select Modem Setup from the Hardware Setup menu, the type of modem installed determines what screen is displayed.

To configure the Signature for ethernet communication, you must have the following information on hand prior to Hardware Setup:

Static IP Address – This is the network address assigned to the Signature flow meter.

TCP Port – The default port setting is 1700. This is the communication port associated with the static IP address on your network.

Gateway Address – The gateway is the point of communication between different networks.

Subnet Mask – This is the umbrella location that allows multiple nodes to communicate within the network.

Special network access may be required to configure these network settings. For further assistance, contact your network administrator.

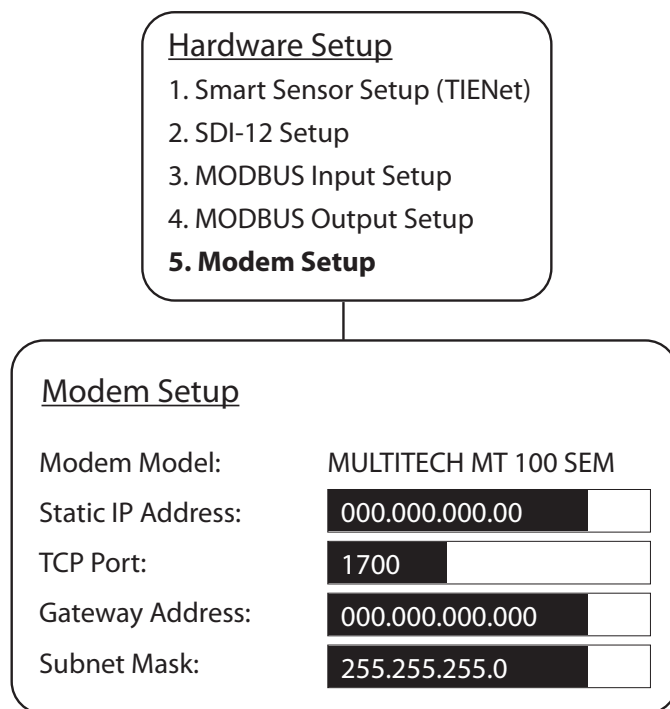

Figure 4-22 Ethernet modem setup: Communication settings (default settings shown)

4.7.2 Network Firewall Settings

In order for your network administrator to identify the Signature in the network firewall setup, it must have a node ID (also known as the MAC address). This is the NODE ID printed on the ethernet modem's serial tag (refer to Figure 4-23).



Figure 4-23 Locating the NODE ID (MAC address) on the ethernet modem

4.8 Cellular Modems

Setup and data retrieval through the Signature's web browser, as well as alarm outputs, can be accomplished remotely with one of the available cellular modems. The whip-style antenna has a magnetic mounting base.



Figure 4-24 Magnetic-mount cellular antenna

4.8.1 CDMA Modem

The Code Division Multiple Access (CDMA) modem can automatically push data to a secure server running Isco Flowlink Pro software, with 1xRTT data transmission.

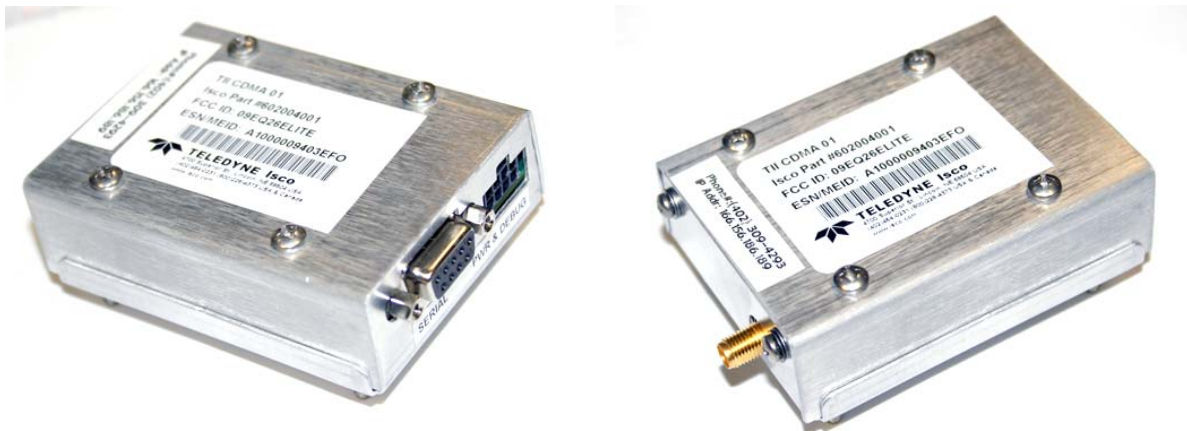

Figure 4-25 CDMA Cellular modem

4.8.2 GSM Modem

The Global System Mobile (GSM) modem can automatically push data to a secure server running Isco Flowlink Pro software, with GPRS data transmission.

Your service parameters, or provider, can be changed by replacing the removable Subscriber Information Module (SIM) card in your modem.

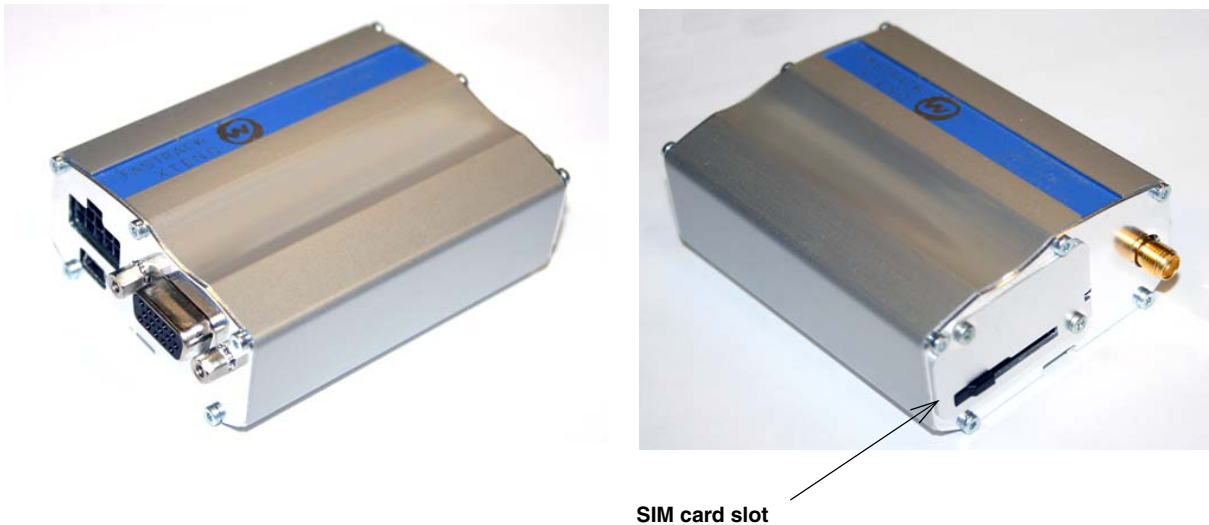

Figure 4-26 GSM Cellular modem

4.8.3 Installing the Cellular Modem

The modem kit includes the modem, power cable, DB9 serial cable, and coaxial antenna plug cable.

1. Remove line power from the Signature Flow Meter and open the case as previously described in Section 3.1.

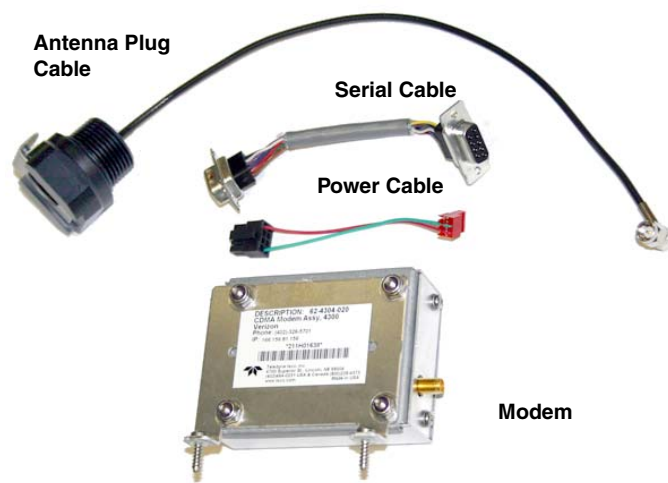

Figure 4-27 Cellular modem kit contents

2. Install the plug in the preferred port (far left most commonly used). Route the antenna plug cable under any other cabling, and install the plug in any open port.
3. Connect the three cables to the modem.
4. Remove the screw retainers and fasten the modem's mounting bracket against the connector case, as shown below, using the two mounting screws.
5. Plug the serial and power cables into their respective connectors on the board.

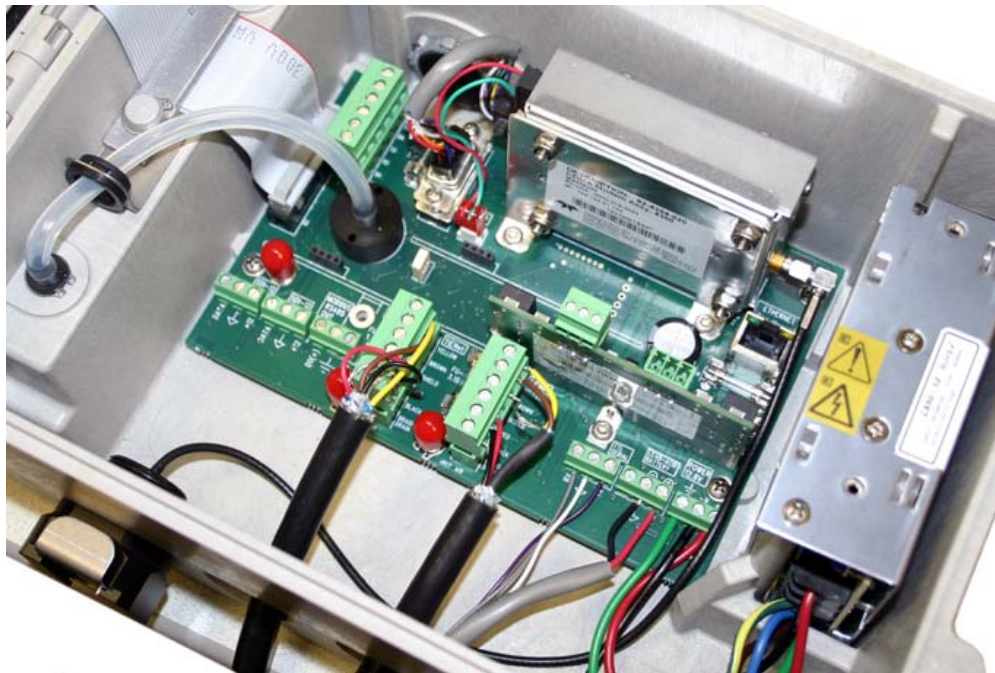

Figure 4-28 Cellular modem installation

4.8.4 Cellular Modem Configuration

When installation is complete and power restored, wait one minute for the Signature to recognize the modem before programming.

When you select Modem Setup from the Hardware Setup menu, the type of modem installed determines what screen is displayed.

To set up the Signature Flow Meter for cellular communication, select either internet (IP) or CSD for the connection.

For the GSM modem, if an Access Point Name (APN) is used, select SINGLE for the operating mode and enter the name.

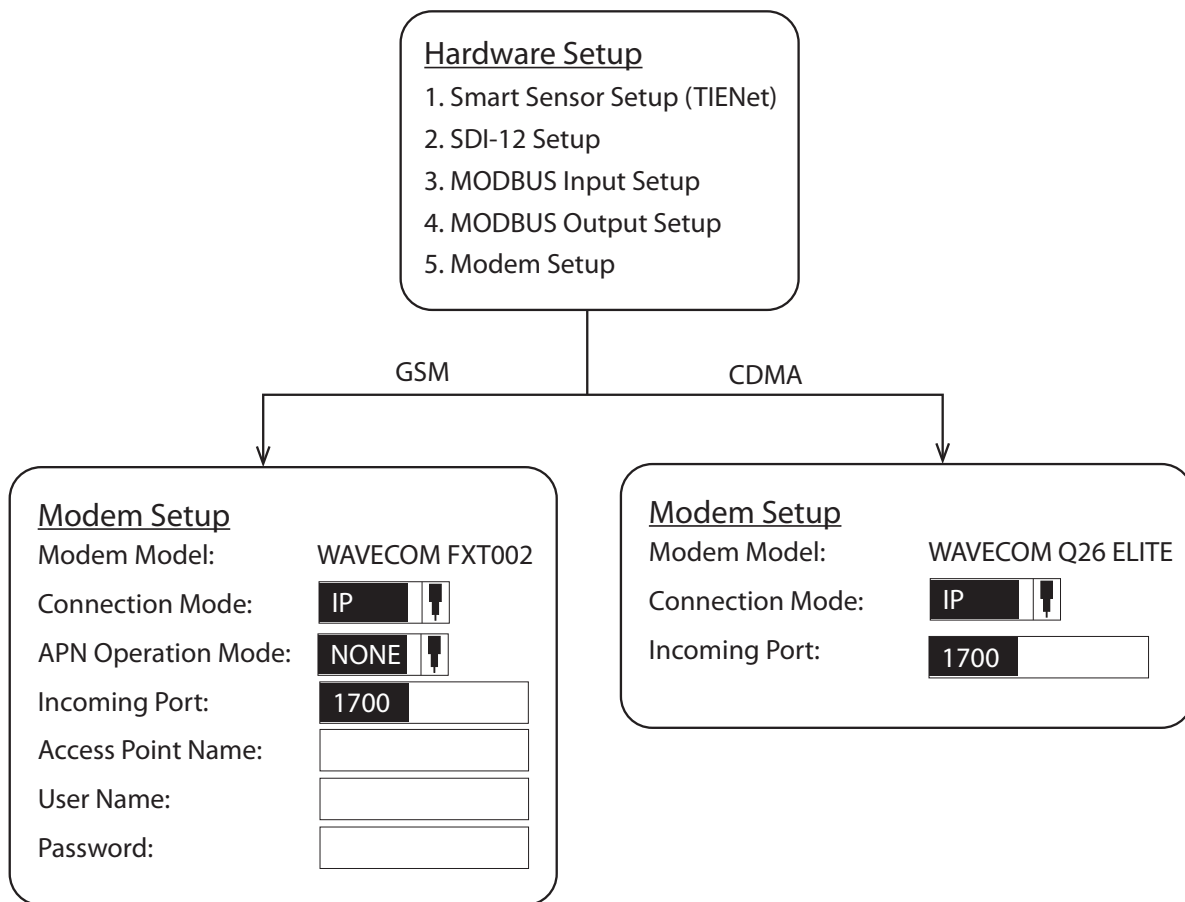

Figure 4-29 Cellular modem setup: Communication settings

Signature™ Flow Meter

Section 5 Maintenance and Servicing

Proper care and regular maintenance of the Signature Flow Meter and associated equipment help to maximize performance and ensure continued operation of the system.

5.1 Cleaning

The Signature flow meter may be cleaned with water and a mild detergent. For hard to remove stains, isopropyl alcohol may be used. If the instrument is in an isolated area and the case is sealed closed, it may be cleaned using a water hose.

5.2 Firmware Updates

Signature and TIENet device firmware updates are provided in the form of .bin files, which will be available for download from the Teledyne Isco website. Note that firmware updates do not remove any program settings or delete data.

To find updates, go to www.isco.com and click on *Software / Firmware Updates* in the lower left corner, then select *Open Channel Flow Measurement*.



Figure 5-1 Locating firmware updates

To install an update:

1. Create a folder in the top directory of a flash drive, and name it BINFILE.
2. Place the new .bin file(s) in the BINFILE folder.

3. Connect the flash drive to a USB micro adaptor cable, and plug the cable into the USB port on the flow meter's front panel.



Figure 5-2 USB Micro adaptor cable (flash drive not included)

4. Once the flash drive is connected to the flow meter's USB port, the USB Options menu will automatically appear on the display. Follow the steps shown in Figure 2-20 *Menu Tree: USB Options*.
5. When the update is complete, the flow meter will automatically restart.

Note

When the Signature displays a notification that it is rebooting, remove the USB cable.

5.3 Desiccant

The inside of the flow meter housing must be kept dry at all times to prevent moisture damage to the internal components. All Signature flow meters have an internal desiccant bag to absorb moisture. Signature flow meters using a 330 bubbler also require an external desiccator.

If increased humidity is indicated by either the humidity reading of the flow meter or the color of the external desiccant, the desiccant must be renewed or replaced before damage occurs.

If this occurs more frequently than expected, inspect the seals of cord-grip fittings and conduit, if used.

Humidity alarm

The humidity of the case interior, reference (ambient) air, and bubble intake air (if a 330 bubbler is installed) are all parameters that can be selected as conditions to trigger an alarm, notifying you when it is time to renew or replace your desiccant.

The suggested alarm setting is a threshold condition of 40%. For detailed instructions about setting up conditions and alarms, refer to Sections *Equation/Trigger Setup*, on page 2-21, and *Outputs/Alarms Setup*, on page 2-23.

5.3.1 Internal Desiccator

Saturated internal desiccant bags must be replaced; unlike the external desiccant, they are not renewable.



Before opening the case, first ensure that mains power is disconnected from the unit.



Before opening the case, disconnect the optional battery backup power, if used.

Open the case, as described in Section 3.1.

The desiccant bag is held in place by a metal bracket. Remove the two screws holding the bracket.



Figure 5-3 Removing the internal desiccant bag

5.3.2 External Desiccator

The desiccator vents the reference port for a pressure transducer, and the air intake port for the bubbler system air pump, keeping the interior of the flow meter case dry.

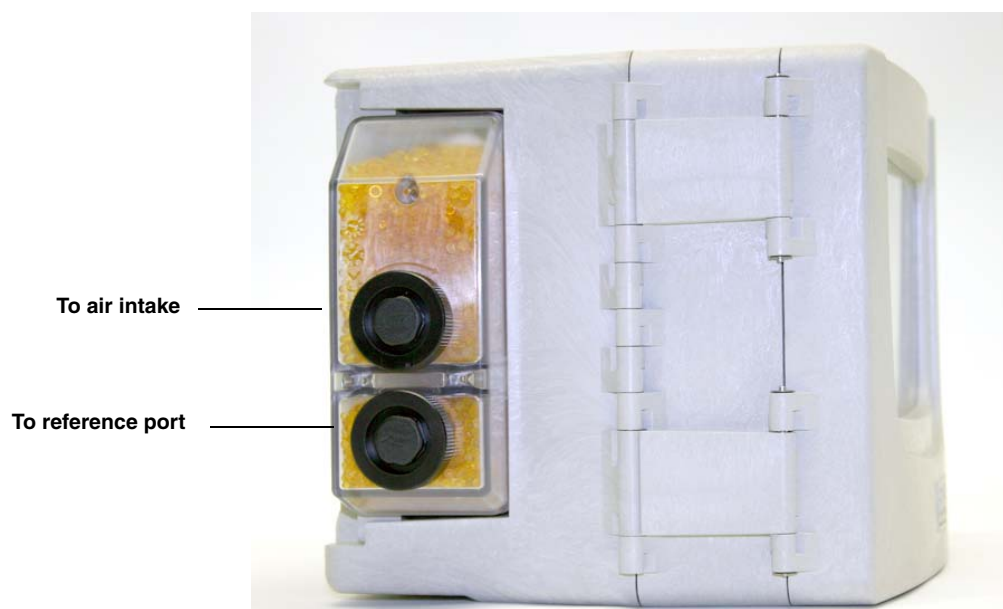

Figure 5-4 External desiccator, installed

When dry, the loose silica gel desiccant inside the chambers is orange or yellow. When the desiccant becomes saturated with moisture, it turns green or blue, indicating that the intake air and reference line are no longer protected from humidity.

✓ Note

Teledyne Isco recommends changing/renewing the desiccant before the entire compartment has changed color.

Dry desiccant
(good)

Saturated
desiccant (bad)



Figure 5-5 Desiccant indicating saturation

The desiccant cartridge is held in place by a spring tab on the side of the flow meter. Press against the front of the cartridge to disengage it from the unit.

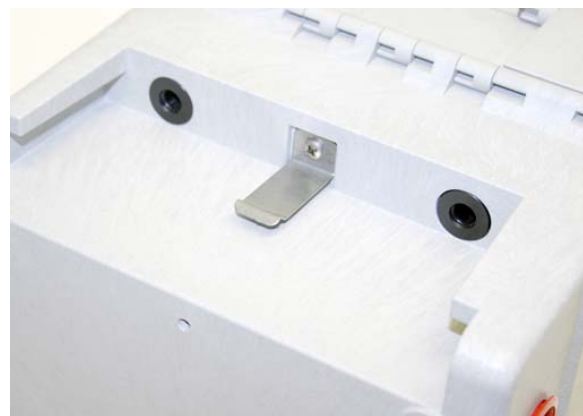
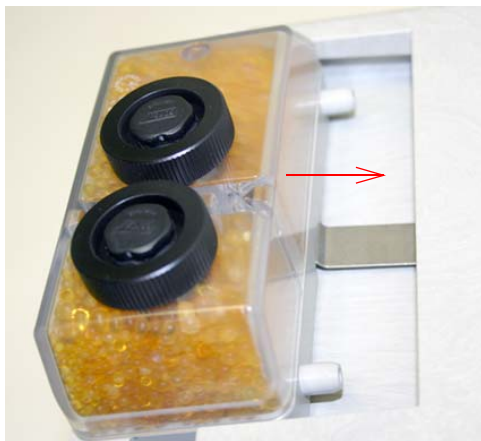
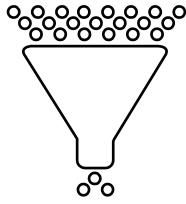

Figure 5-6 Removing the external desiccant cartridge

Unscrew the two black caps and carefully pour the desiccant out. If removal is difficult, screw the caps back in and unscrew again. Gently knock the caps and the cartridge against a hard surface to free any small particles in the threads, as these can hinder proper sealing and cause wear.

Use a funnel to refill the desiccator.



Using a funnel, fill both chambers with dry desiccant, replace the caps, ensuring that they are fully engaged. Press the cartridge back into place on the side of the flow meter.

Note

If this is a new desiccant cartridge, remove the two red protective end caps from the ports before installing a new cartridge.



Remove red caps before installing cartridge.

Figure 5-7 Opening the desiccant cartridge chambers

Renewing loose desiccant

To renew the desiccant, spread it in a single layer on a flat metal tray. Place in a vented, circulating forced air, conventional oven in a well ventilated room, and heat at 100 - 175°C (212 - 350°F) for about three hours, or until the color has returned to orange or yellow.

MSDS (Material Safety Data Sheets) for silica gel chemicals are provided in Appendix C.

5.4 Troubleshooting

The tables in the following section provide troubleshooting information to help in determining the causes of problems that may occur with the Signature flow meter or TIENet devices.

The troubleshooting tables cover the flow meter and each TIENet device separately. Note that the 300 TIENet device (Table 5-2) is the internal connector case.

Note

Any time a circuit board is replaced or a sensor disconnected, you MUST perform a hardware scan and SDI-12 scan (if connected) before resuming operation.

5.4.1 Signature Flow Meter

Table 5-1 Troubleshooting: Signature Flow Meter			
Symptom	Cause	Action	Parts
Blank Display but audible beep when a key is pressed	Contrast is out of adjustment	Adjust the display contrast by repeatedly pressing the up or down arrow while holding down the +/- key.	
	Faulty Display	Replace with known good display.	Display 130-0602-06
Blank Display and no beep when a key is pressed	DC power supply not supplying 12.8 VDC output.	Check for proper AC voltage. If proper AC voltage is present, replace DC power supply.	DC Power Supply 60-4304-037
		Service check: Disconnect the internal power supply wires (Red +/pos, Black –/neg) from the power terminals (Figure 3-2 <i>Connector case, connectors, and fuses</i> , Item F). Connect an Isco adaptor cable to the power terminals (Black +/pos, White –/neg). Then connect an Isco power supply (Model 913, 914, 923, or 924) to the adaptor cable. If the Signature then functions properly, replace the internal power supply.	Isco Adaptor Cable 69-4304-034
	Broken or loose wire from power supply module to the connector case.	Repair connections (Red +/pos, Black –/neg).	
	Open Fuse F3	Replace 4A/250V/5X20mm Slo Blo fuse (Figure 3-2 <i>Connector case, connectors, and fuses</i> , Item L). If the fuse opens again, check for devices that may be shorting the supply, such as a modem or option card.	4A Fuse 411-9901-84
	CPU board faulty	Substitute with known good CPU board.	CPU Board 60-4304-042
	Faulty or missing SD card	Reinstall or replace SD card on CPU board.	SD Card 250-3000-66
	Defective keypad	Substitute a known working keypad.	Keypad 69-4303-009

Table 5-1 Troubleshooting: Signature Flow Meter (Continued)

Symptom	Cause	Action	Parts
Nonresettable totalizer does not advance	Defective totalizer	Replace totalizer	Mechanical Totalizer 60-4304-015
	Programming error - Zero flow rate or asterisk (*)	Check measurement configuration of level, flow rate, and volume input for the Total Flow parameter.	
	Broken wire connection	Check wire connections for the totalizer on the CPU board.	
USB device not recognized - No USB Options screen	Meter was booted up with USB adapter cable connected.	Remove USB adapter cable and reboot the meter	
	Meter was booted up with USB to computer cable connected.	Remove USB to computer cable and reboot the meter	
	Flash drive encrypted or defective	Try a different USB Flash drive	
	USB port damaged	Replace port	USB Port 60-4304-033
	Adaptor cable defective	Replace cable	USB Adaptor Cable 480-2946-02
Cannot update software / Read flash drive	The necessary files are not on the flash drive.	Load the firmware from our website onto the flash drive, into a folder named BINFILE.	www.isco.com
	SD Card not functional or missing files.	Verify that the SD card includes a BINFILE folder with the appropriate .bin file(s) inside.	
	Faulty CPU board	Replace the CPU board.	CPU Board 60-4304-042

5.4.2 TIENet 300 Connector Case

Table 5-2 Troubleshooting: TIENet 300 Connector Case			
Symptom	Cause	Action	Part
TIENet or SDI12 devices not appearing on display for configuration Refer to Section 2.6.1 <i>Smart Sensor Setup (TIENet)</i>	Device has not been scanned.	Perform a hardware scan from Smart Sensor Setup or SDI-12 Setup. Refer to Sections 2.6.1 <i>Smart Sensor Setup (TIENet)</i> and 2.6.2 <i>SDI-12 Setup</i> .	
	Device is not wired correctly.	Rewire connector following label on the case circuit board.	
	Open Fuse	Check fuse F1, F4, F5. Replace if open. Refer to Figure 3-2 <i>Connector case, connectors, and fuses</i> , Item K.	3.15A Fuse 411-0212-70
	Defective TIENet or SDI12 device.	Substitute a known working device and rescan. If it now works, replace the faulty device.	
	Device not configured for display on the Home Display.	Add the parameters to the Home Display. Refer to Section 2.7.1 <i>Site Setup</i> .	
	Case circuit board faulty.	Substitute with known working board.	300 Connector Case 60-4304-041
	CPU Board faulty.		CPU Board 60-4304-042
	CPU to connector board ribbon cable damaged.	Substitute with known working cable.	Ribbon Cable 69-4304-032
Wired incorrectly.	Repair/rewire per the label on the connector case.		

5.4.3 TIENet 301 pH/Temp

Table 5-3 Troubleshooting: TIENet 301 pH/Temperature Device			
Symptom	Cause	Action	Part
pH Will not calibrate	Probe defective	Replace probe	pH Probe 60-9004-126
	301 module not recognized	Rescan device in Hardware Setup	
		Check TIENet wire connections. Follow wiring code silk-screened on circuit board.	
	No sensor connected to the 301	Connect pH probe	
TIENet connection fuse open	Replace if open.	3.15A Fuse 411-0212-70	

Table 5-3 Troubleshooting: TIENet 301 pH/Temperature Device (Continued)

Symptom	Cause	Action	Part
Incorrect pH readings / slow response	Buffers contaminated or wrong buffer used.	Use new/correct pH buffer solution.	
	Temperature is not being read.	Replace probe	pH Probe 60-9004-126
	Probe bulb is contaminated	Clean probe and recalibrate. If readings are still incorrect, replace probe.	
	Calibrated before reading stabilized.	Recalibrate and allow the readings to stabilize before continuing with calibration.	

5.4.4 TIENet 306 Sampler Interface

Table 5-4 Troubleshooting: TIENet 306 Sampler Interface

Symptom	Cause	Action
Incorrect pacing interval	Incorrect flow total selected for pacing	Assign the correct sensor to the correct flow rate to the correct total flow. Example: Needed to pace from the 330 bubbler, but programmed to pace from the 310 USLS.
No sampler pacing	Sampler's flow pulse input not working	Connect a different sampler, or test the existing sampler by shorting pins A and C on the sampler's Flow Meter port, while the program is running. The displayed pulse count should count down.

5.4.5 TIENet 308 Analog Output

Table 5-5 Troubleshooting: TIENet 308 4-20mA Analog Output

Symptom	Cause	Action
4-20 output is missing, or zero current output	Incorrect wiring	Rewire per connector diagram
	Excessive load	Disconnect external equipment and test the output with VOM. If OK then reduce load resistance (maximum 500 Ω) or add <u>isolated</u> power to the current loop.
	Analog circuit board failure	Use the other output on the 308 circuit board. If current is still 0 mA, replace circuit board. If the VOM reads 4mA or greater, reprogram to use that output or replace the circuit board. Part #60-4304-006

Table 5-5 Troubleshooting: TIENet 308 4-20mA Analog Output (Continued)

Symptom	Cause	Action
4-20 only reads 4mA	Wires on incorrect output (wired to output 2 instead of output 1)	Move connector to proper output
	Analog percent is not selected in the TIENet sensor configure options in Hardware setup	Reconfigure the TIENet 308 Refer to Sections 2.6.1 <i>Smart Sensor Setup (TIENet)</i> and 2.7.7 <i>Outputs/Alarms Setup</i> .
	Improper parameter set for the output.	Verify/change the settings/range to the proper parameter.
4-20 reading incorrectly	Excessive load	Disconnect external equipment and test the output with VOM. If OK then reduce load resistance (maximum 500 Ω) or add <u>isolated</u> power to the current loop.
	Improper module/parameter set for the output	Verify/change the settings/range to the correct module/parameter.
	Connected to incorrect output; e.g., wired to output 2 instead of output 1	Move connector to proper output
Analog is not available under Outputs menu	TIENet 308 is not properly configured	Verify the TIENet configuration contains analog percent readings
Measurement error for analog current	No load applied to the output circuit, or open circuit wiring.	The output must have a load resistance (maximum 500 Ω). For verification, this can be accomplished by connecting the current meter leads to the terminals of the 308 card.

5.4.6 TIENet 310 USLS

Table 5-6 Troubleshooting: TIENet 310 Ultrasonic Level Sensor

Symptom	Cause	Action
Invalid level, display has asterisk (*) by level reading	Not scanned	Perform a smart sensor scan
	Not able to achieve signal lock (misalignment, loose mounting, turbulence, foam, or debris in the water)	Adjust mounting or place over a solid surface.
	Level outside of the Blanking distances	Adjust min/max blanking distances
	Not wired correctly	Check/repair wiring
	Open fuse	Replace fuse and rescan. Part #411-0212-70
	Failed sensor	Replace with known good sensor
No level reading on the display	Parameter not selected to be displayed on Home Display	Add the parameter to the Home Display. Refer to Section 2.7.1 <i>Site Setup</i> .

Table 5-6 Troubleshooting: TIENet 310 Ultrasonic Level Sensor (Continued)

Symptom	Cause	Action
Incorrect level reading	Level not adjusted properly	Readjust level
	Sensor misaligned	Realign sensor
	Objects in the path of the signal	Adjust min/max blanking distances and/or reposition sensor.
	Sensor exposed to direct sunlight	Install sunshade. Refer to Appendix B.3 <i>TIENet Devices and Accessories</i> .

5.4.7 TIENet 330 Bubblers

Table 5-7 Troubleshooting: TIENet 330 Bubblers Module

Symptom	Cause	Action
No bubble out	Bubble line from Signature to primary device (weir/flume) damaged or blocked.	Clear blockage or replace bubble line. Perform a manual purge before resuming operation.
	Plugged orifice	Replace orifice/bubbler device
	Pump motor failure	Replace motor/bubbler device
	Damaged/pinched bubble line	Replace bubble line
	Blocked inlet air line	Remove the exterior desiccator and perform a manual purge. If the pump runs and has an output, repair/replace desiccator.
	Interior air line leaking/failure	Repair/replace damaged air lines
Invalid level reading display; Asterisk (*) displayed next to reading.	Blocked bubble line	Remove bubble line to see if the bubbler will start reading. If yes, replace bubble line.
	Interior air line leaking/failure	Inspect all air lines and repair/replace where needed. Perform a manual purge.
Incorrect level reading	Bubble line starting to clog	
	Incorrect level adjustment.	
	Bubbler module failure	Replace the module

5.5 330 Bubbler Installation

The TIENet 330 bubbler device is factory-installed for Signature bubbler flow meters. It can also be installed by the user to convert a Signature flow meter into a bubbler, or to replace an old 330 device.

DANGER

Before opening the case, first ensure that mains power is disconnected from the unit.

CAUTION

Before opening the case, disconnect the optional battery backup power, if used.

Open the case, as described in Section 3.1.

If no bubbler was previously installed, remove the cover shield over the main CBA. This will not be used again, since the 330 bubbler assembly includes its own cover shield.



Figure 5-8 Remove non-bubbler shield

If you are replacing an existing 330 bubbler, to ensure that the bubble line tubing is reconnected correctly, label the tubing ends, then remove the four mounting screws holding the 330 bubbler module in place (see Figure 5-9).

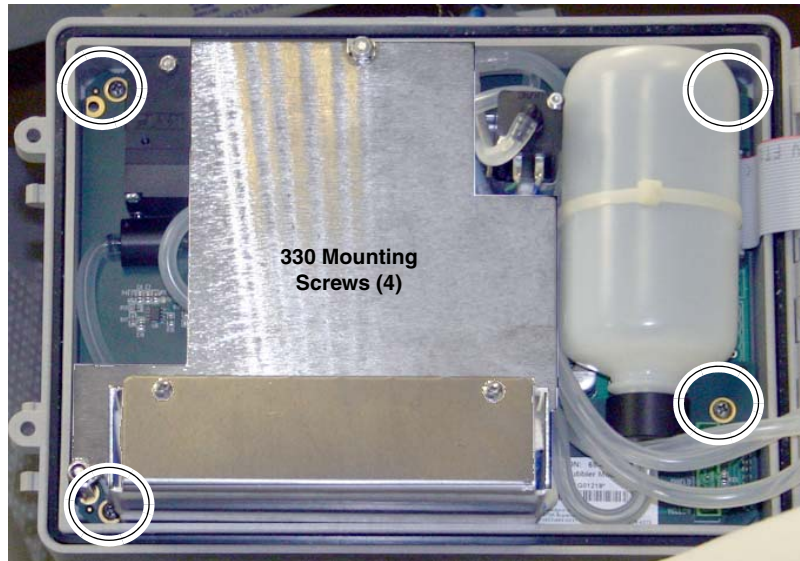

Figure 5-9 Remove bubbler module

Installation

Referring to Figures 5-10, and 5-11, perform the following steps.

1. Place the bubbler assembly on top of the main CBA, ensuring that the four screw holes line up in the case, and the 10-pin connector engages correctly in its socket.
2. Attach the bubbler board to the control panel using the four self-tapping screws previously (part #231-6149-07). Do not overtighten.

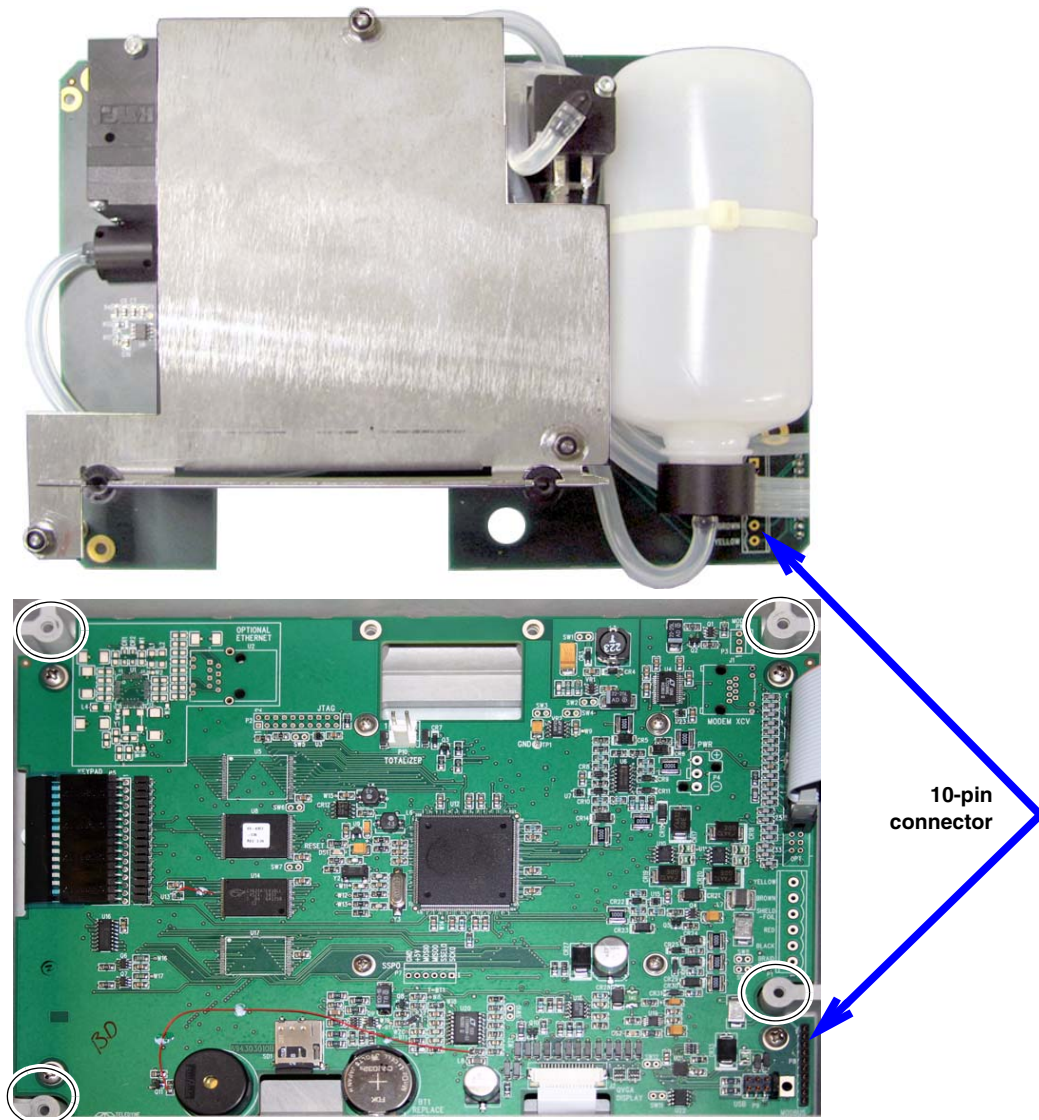

Figure 5-10 330 Bubbler assembly installation

✓ Note

There are three pieces of tubing on the bubbler that must be correctly connected for operation. If any tubing is damaged, please purchase 1 meter of part #029-1353-02 and cut to the length needed for replacement. For additional information about tubing connections, refer to Section A.3 330 Bubbler in Appendix A Replacement Parts.

3. Replace the port plug in the bottom of the case (usually second from the left) with the bubble line fitting.
4. Route the reference line tubing (with fitting on the end) through the bushing and press the fitting into the reference connector on the connector case.

5. Route the intake tubing (the shorter of the two open-ended tubes) through the bushing and behind the ribbon cable, and connect it to the intake port in the case wall.
6. Route the other end of the short tubing through the bushing and connect it to the humidity connector on the board.
7. Connect the bubble tubing (the longer of the two open-ended tubes) to the bubble line port in the bottom of the case.

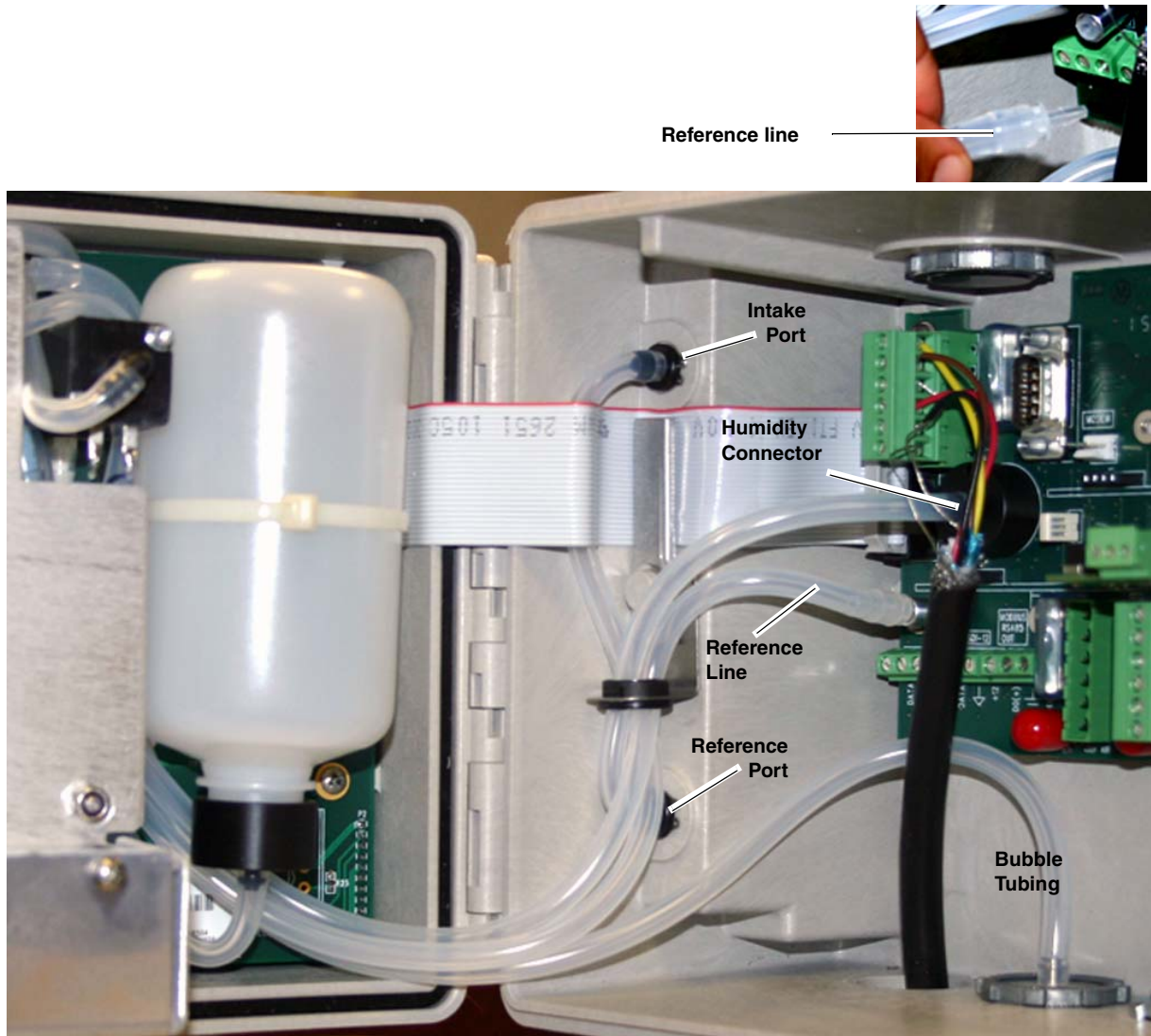

Figure 5-11 Routing and connections of 330 bubbler tubing

5.6 Front Cover Replacement

A replacement front cover (door) comes with latches attached, and two new hinge pins.

Align the hinges of the front cover front panel. Press the pins into the hinge barrels, with each flange facing inward (refer to Figure 5-12), until it is flush against the hinge surface.

Using a vice grip or other tool, spread and flatten the outward facing ends of the pins so they cannot be removed from the hinges.

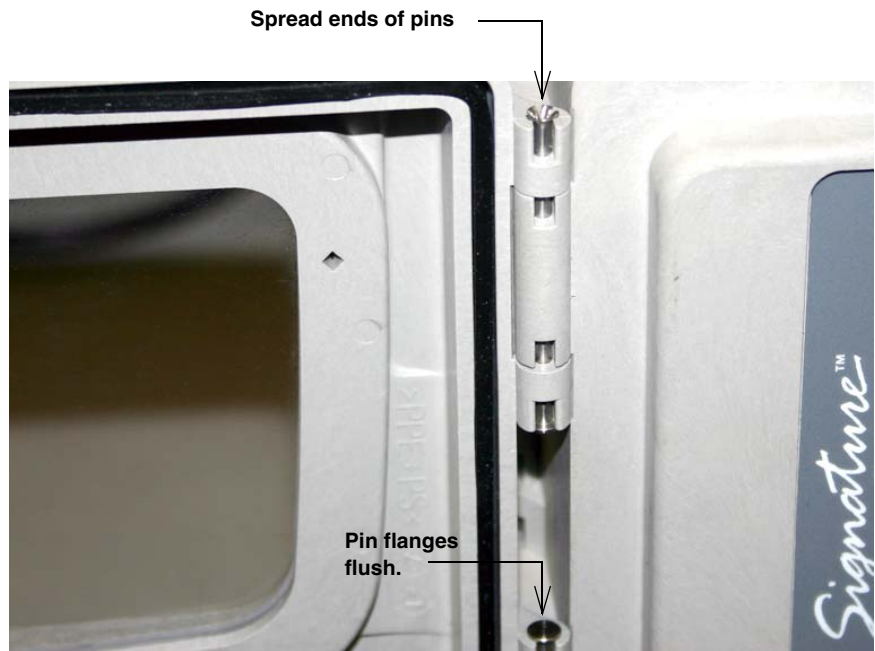

Figure 5-12 Front cover (door) replacement

5.7 System Reset

In the event that the Signature Flow Meter becomes unresponsive, operation may be restored by removing and then restoring line power.

If the problem persists, operation may be restored by performing a hard reset.

⚠ CAUTION

A hard reset erases site data and restores the program to factory default settings.

To perform a hard reset, first remove line power. Then, while holding down both the Home key and the Delete key, restore line power.

5.8 Service and Repair

Teledyne Isco
Technical Service Dept.
P.O. Box 82531
Lincoln, NE 68501 USA

Phone: 866 298-6174
402 464-0231
FAX: 402 465-3085

E-mail:
IscoService@teledyne.com

Service tasks described in this manual may be performed on site by properly trained personnel. Other service and repairs must be performed at the factory. If you believe your Teledyne Isco equipment requires repair, contact Teledyne Isco's Technical Service department.

Speaking with a Teledyne Isco Technical Service representative can often resolve the problem without the need to return the item. If the issue cannot be resolved by phone or email, you will receive a Return Authorization Number (RAN) and information on returning the equipment to the factory.

Signature™ Flow Meter

Appendix A Replacement Parts

Replacement parts are called out in illustrations in this section. Reference the call-outs in the accompanying tables to determine the part number for the item.

A.1 How to Order

Replacement parts can be purchased by contacting Teledyne Isco's Customer Service Department.

Teledyne Isco
Customer Service Dept.
P.O. Box 82531
Lincoln, NE 68501 USA

Phone: 800 228-4373
402 464-0231
FAX: 402 465-3022

E-mail: IscoInfo@teledyne.com

A.2 Signature Flow Meter

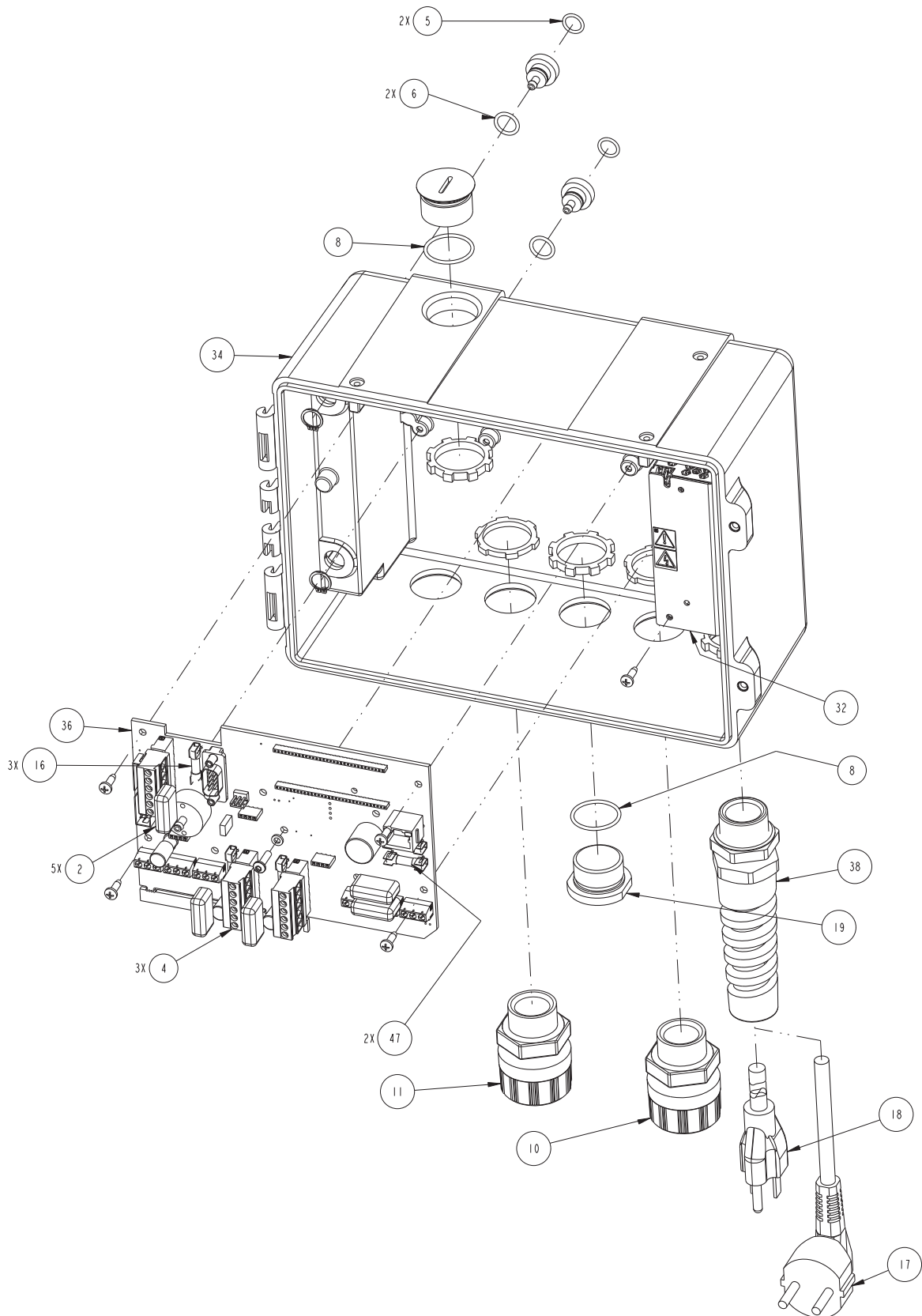

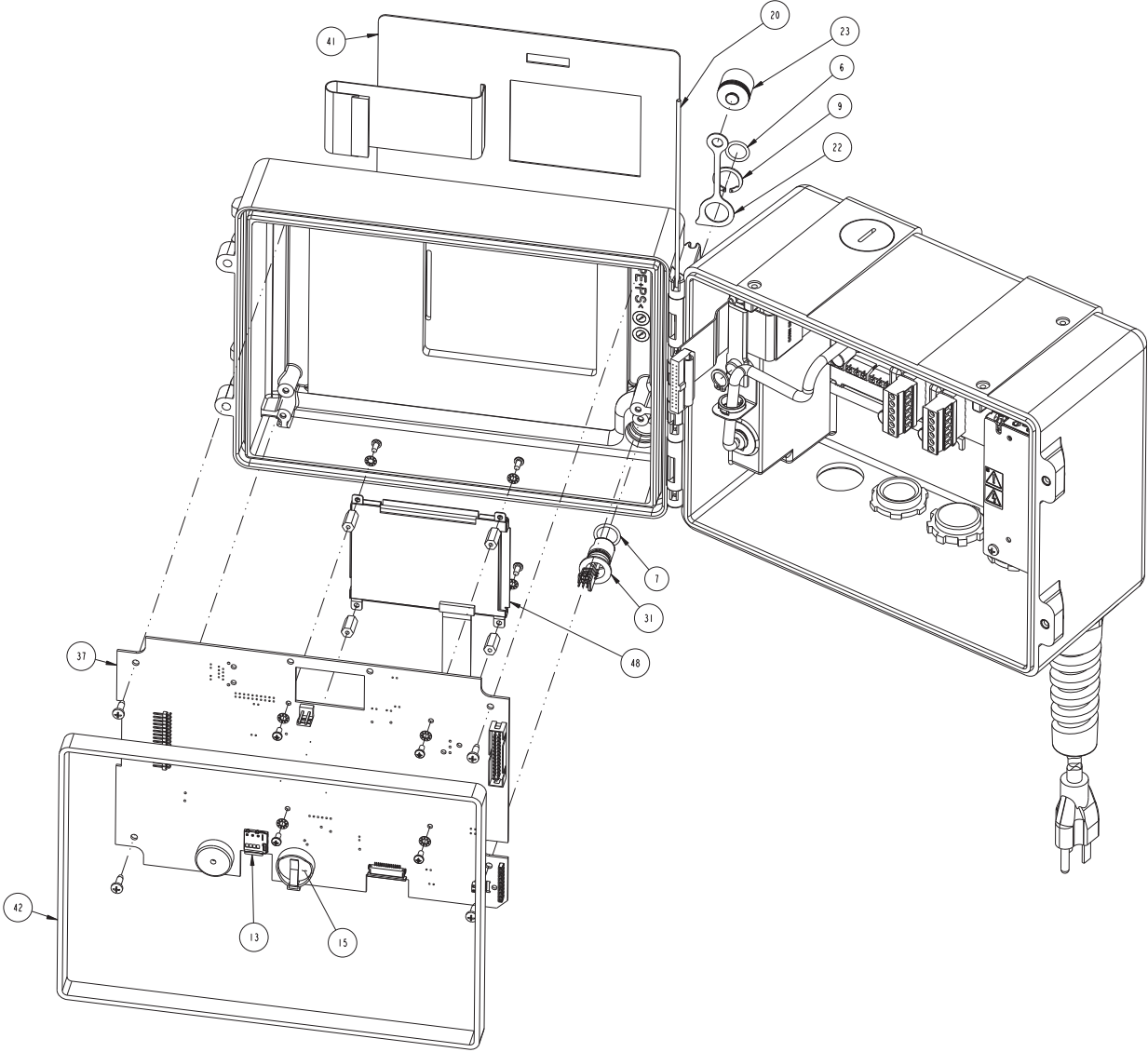

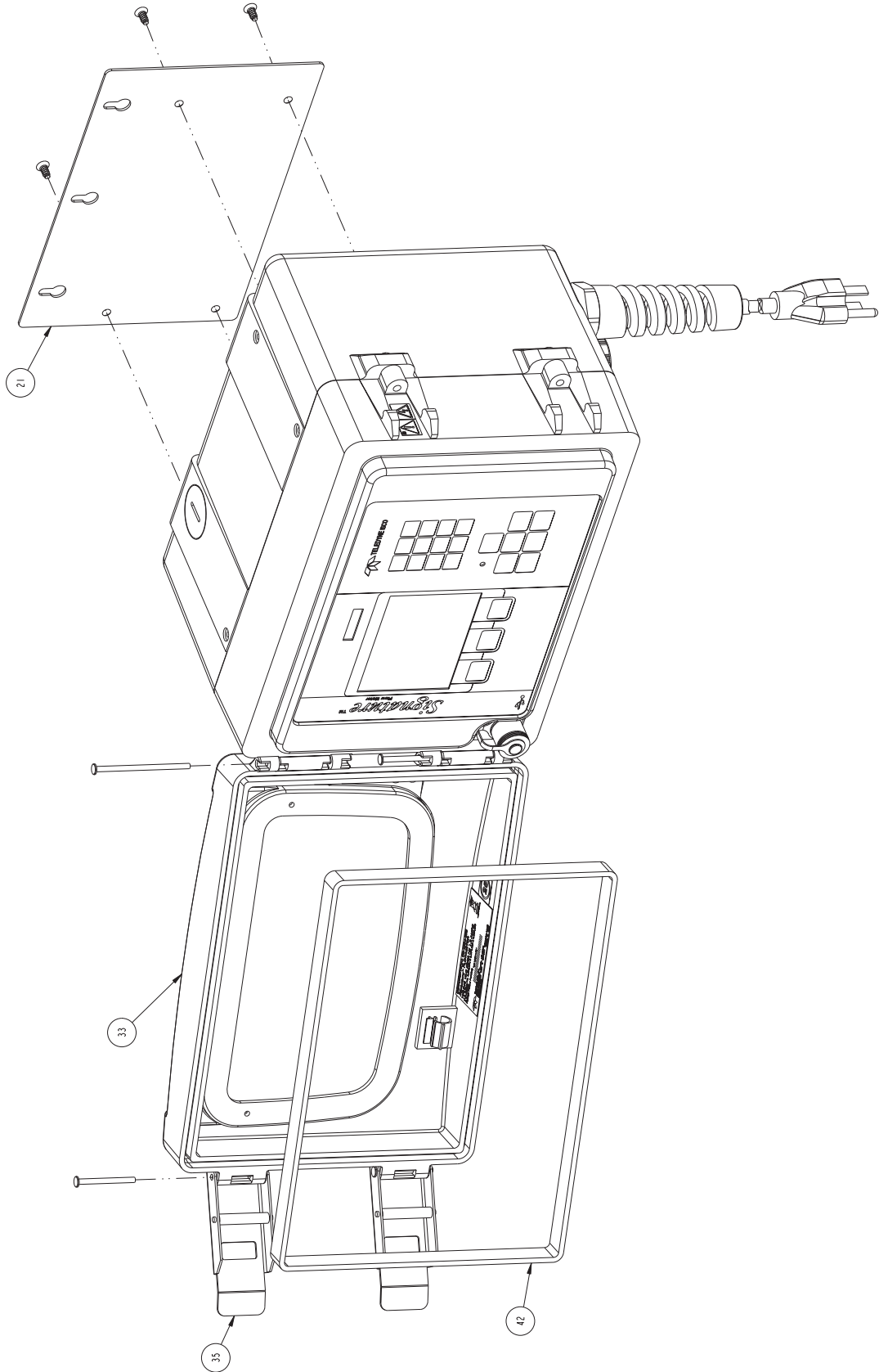

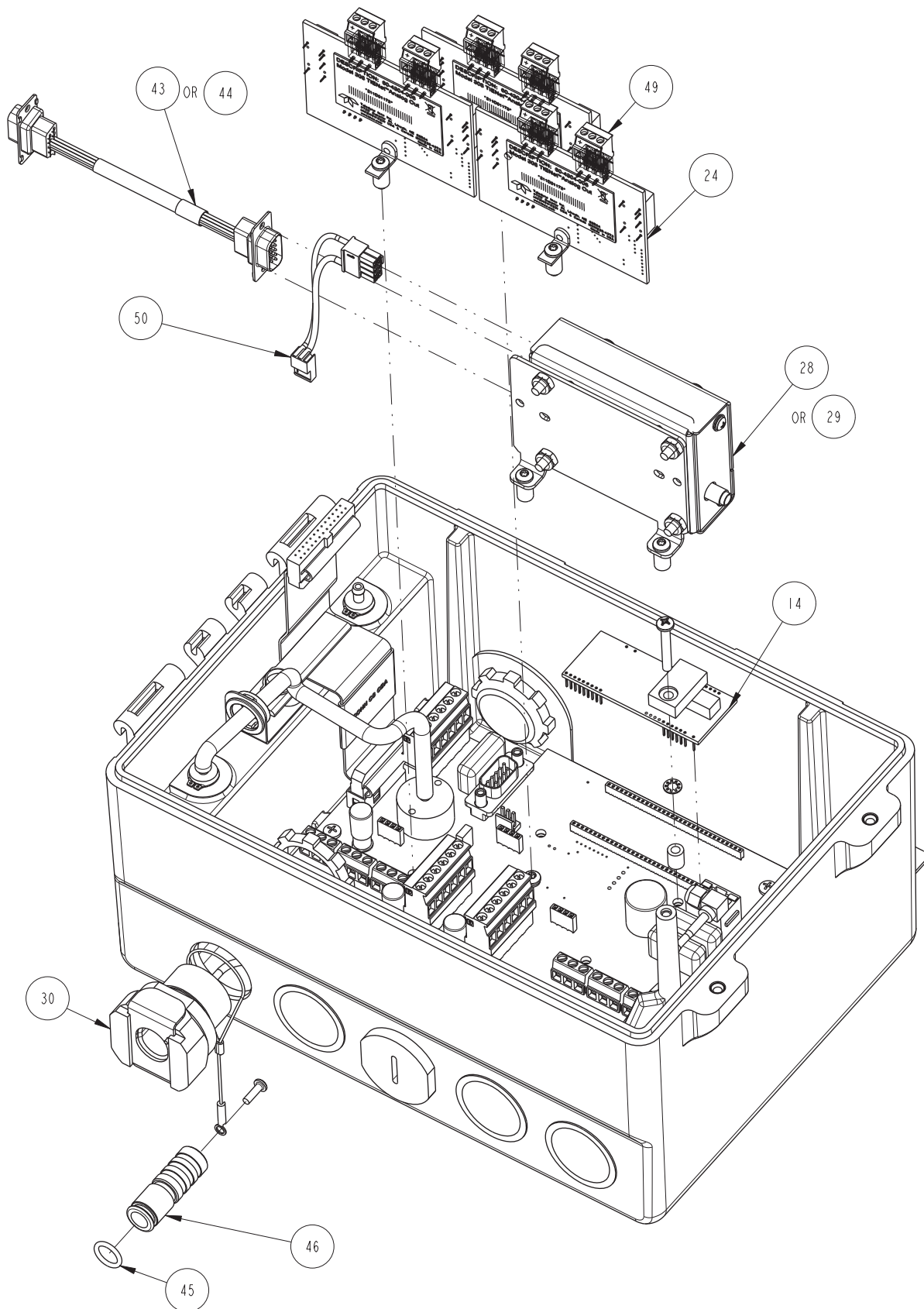

Continued on following page.

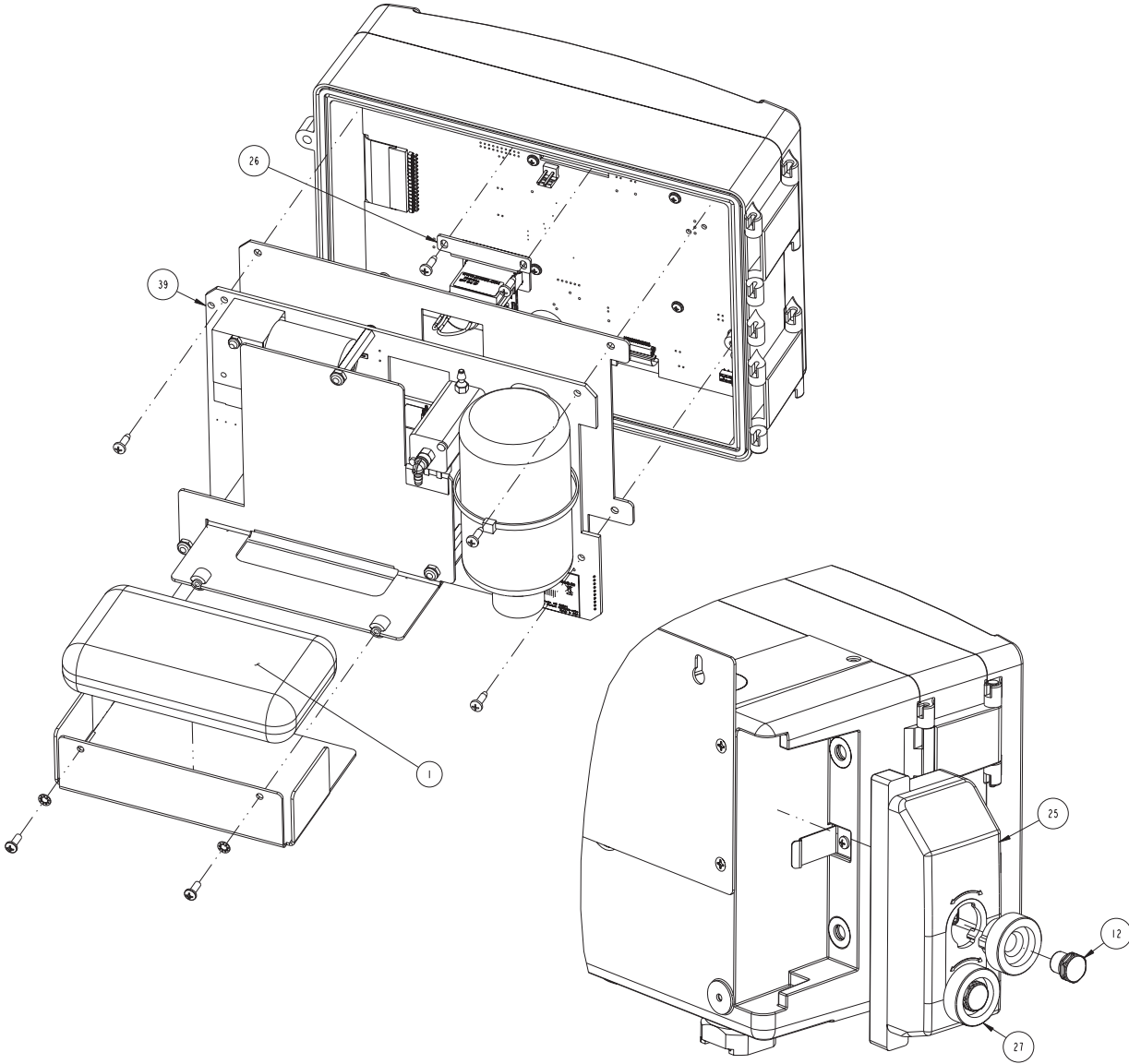

REPLACEMENT PARTS LIST		
TELEDYNE ISCO, INC.		
		604302038
		SHEET: 8 OF 8
		REV: B
ITEM NO.	PART NUMBER	DESCRIPTION
1	099000200	DESICCANT 8OZ BAG
12	209009393	SCREW IN HYDROPHOBIC FILTER
14	250300067	10/100 BASE T ETHERNET MODEM
24	604304006	ANALOG OUTPUT CARD ASSEMBLY
25	604304013	DESICCANT ASSEMBLY
26	604304015	COUNTER ASSEMBLY
27	604304016	DESICCANT CAP ASSEMBLY
28	604304020	CDMA MODEM ASSEMBLY
29	604304021	GSM MODEM ASSEMBLY
30	604304027	COAX CABLE AND CLIP ASSEMBLY
39	604334003	BUBBLER MODULE ASSEMBLY
43	694304028	SERIAL CABLE ASSEMBLY (CDMA)
44	694304029	SERIAL CABLE ASSEMBLY (GSM)
45	202307012	O RING .364ID .070
46	602003568	PLUG FEMALE ANTENNA
49	141930003	3 PIN HEADER SOCKET
50	602004530	8 PIN POWER CABLE ASSEMBLY
51*	602004233	SILICA GEL DESICCANT BOTTLE
52*	601703060	ADAPTER TUBE 1/16" BUBBLE LINE
53*	601873048	SUPPORT TUBE 1/16" BUBBLE LINE
*	NOT SHOWN	
NOTE: 1. For current prices and quotations on parts, contact Isco Service Department. 2. This list is subject to change without notice.		

A.3 330 Bubbler

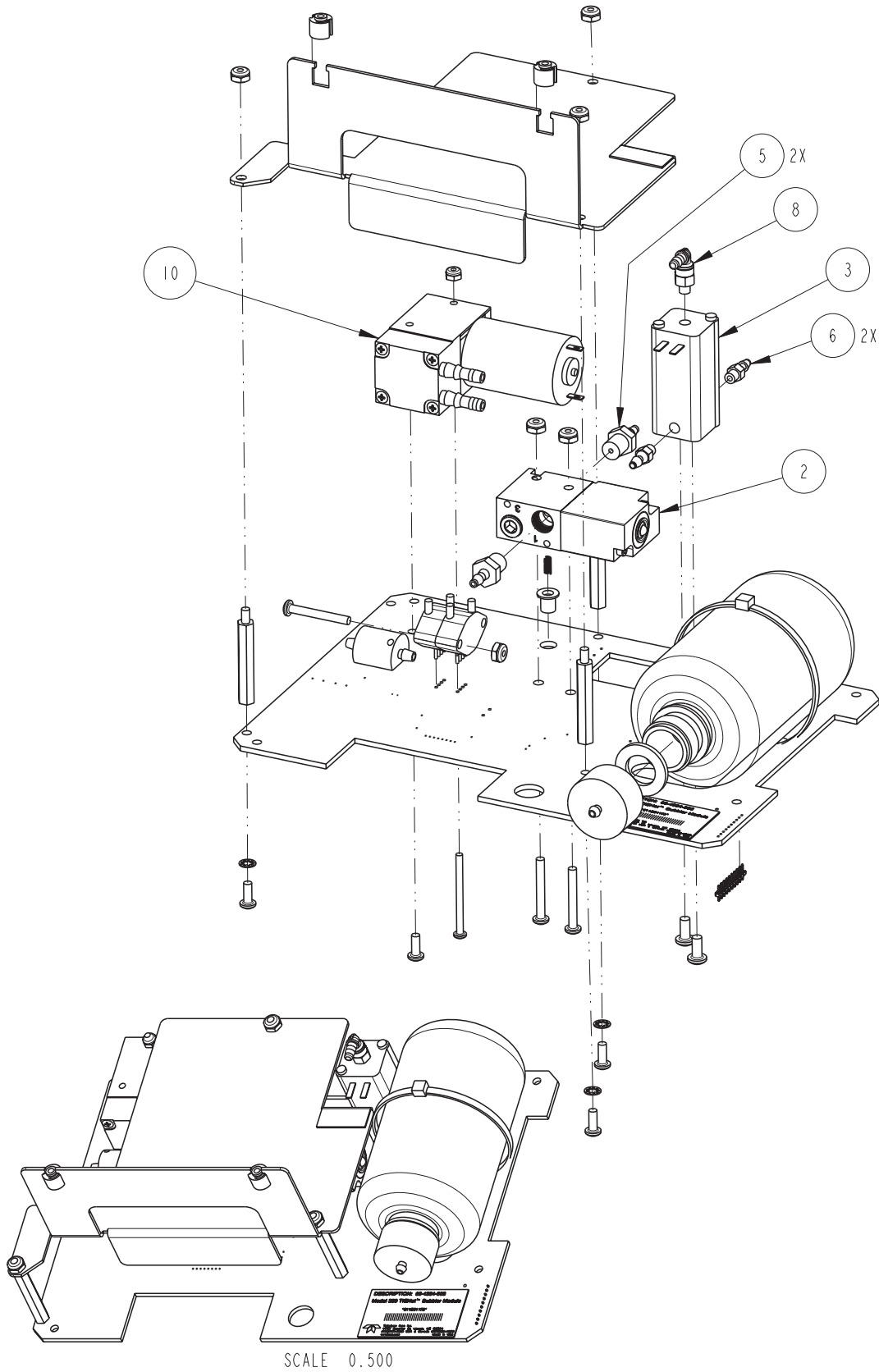

Signature™ Flow Meter

Appendix B Options and Accessories

B.1 Ordering Information Options and accessories can be purchased by contacting Teledyne Isco's Customer Service Department.

Teledyne Isco
Customer Service Dept.
P.O. Box 82531
Lincoln, NE 68501 USA

Phone: 800 228-4373
402 464-0231
FAX: 402 465-3022

E-mail: IscoInfo@teledyne.com

B.2 Signature Flow Meter Accessories

Cord grip fitting for TIENet cable	209-0073-12
<i>³/₄" NPT .375 / .437" OD</i>	
Cord grip fitting for Battery backup cable	209-0073-11
<i>³/₄" NPT .250 / .375" OD</i>	
Cord grip fitting with flexible strain protection	60-4307-022
Exterior desiccator - Required for use with 330 and 350 TIENet devices	60-4304-013
TIENet Expansion Box	60-4307-023
<i>Kit includes 10ft TIENet cable</i>	
Bulk TIENet Cable, 23m.....	60-4303-065
Battery Backup: 946 Lead-acid battery pack, connect cable, and battery mounting hardware.....	60-4307-015
Lead-acid connect cable.....	69-4304-034
117V Power cord kit	60-4304-044
<i>Includes strain relief cord-grip fitting</i>	
240V Power cord kit	60-4304-045
<i>Includes strain relief cord-grip fitting</i>	
117V Power cord.....	60-1683-216
240V Power cord.....	48-0124-101
USB Flash drive, 2GB.....	250-3000-42
Adaptor cable, USB Micro to USB-A.....	480-2946-02
USB connect cable, Signature to PC	480-2946-01
ProHanger SST Suspension bracket for 18 - 24in. manhole shaft	69-2003-599
Spreader bar for suspension of sensor or flow meter in manhole shaft	60-3004-110

Suspension harness	60-1704-016
7-Digit, non-resettable mechanical totalizer.....	60-4304-015
Dri-Can Desiccant	099-0012-00
8oz. Desiccant bag	099-0002-00
Gore Filter	209-0093-93

B.3 TIENet Devices and Accessories

310 Ultrasonic sensor w/ 10m cable	60-4314-005
310 Ultrasonic sensor w/ 23m cable	60-4314-006
Sunshade for ultrasonic sensor	60-3004-142
Ultrasonic sensor cable clamp	60-3004-129
Ultrasonic sensor wall bracket for vertical surface	60-2443-092
Ultrasonic sensor floor mount for horizontal surfaces	60-2004-611
Ultrasonic sensor cable straightener for suspension over stream.....	60-3213-061
Ultrasonic calibration target	60-3004-143
306 Sampler Interface w/ 5m cable	60-4304-017
306 Sampler interface w/ 10m cable.....	60-4304-007
306 Sampler interface w/ 23m cable.....	60-4304-008
308 Two analog output interface card.....	60-4304-006
301 pH/Temperature Device w/ 10m cable	
<i>Includes combination pH probe with built-in exposed temperature probe and 25 ft. probe cable.</i>	
<i>Includes one package of each buffer and rinse solution for probe calibration.</i>	60-4307-018
301 pH/Temperature Device w/ 23m cable	
<i>Includes combination pH probe with built-in exposed temperature probe and 25 ft. probe cable.</i>	
<i>Includes one package of each buffer and rinse solution for probe calibration.</i>	60-4307-019
pH Probe (only).....	60-9004-126
Probe Carrier for pH probe	60-3208-001
330 Bubbler sensor	60-4334-003
Bubble line, PTFE, 1/16" x 25ft	60-1873-051
Bubble line, vinyl, 1/8" x 50ft	60-1873-044
Bubble line, vinyl, 1/8" x 100ft	60-1700-003
SST Bubble tube, 4ft long - for PTFE, 1/16" Line	60-1704-018
SST Bubble tube, 4ft long - for PTFE, 1/8" Line	60-1873-043
Bubble line carrier - attach to Isco Mounting Ring	60-3204-007
Reference port tubing kit	60-4307-017

<p> Note</p> <p>Teledyne Isco uses FreeRTOS version 5.4.2 in its TIENet devices. In accordance with the FreeRTOS license, FreeRTOS source code is available on request. For more information, visit www.FreeRTOS.org.</p>

B.4 Modems

CDMA Digital cellular modem (Cellular service not included.)	60-4307-020
Magnetic mount antenna for CDMA	60-2004-550
GSM Digital cellular modem (Cellular service not included.)	60-4307-021
Magnetic mount antenna for GSM	60-2004-551
Ethernet modem	60-4307-016

B.5 Sensor Mounting Rings

B.5.1 Spring Rings

Probe Mounting Ring for 6" pipe	68-3200-007
Probe Mounting Ring for 8" pipe	68-3200-008
Probe Mounting Ring for 10" pipe	68-3200-009
Probe Mounting Ring for 12" pipe	68-3200-010
Probe Mounting Ring for 15" pipe	68-3200-011

B.5.2 Scissor Rings

Base Section (with tabs for mounting up to five probes)	60-3004-169
Scissors Assembly	60-3004-170
Extension 1 (9.0")	60-3004-172
Extension 2 (21.5")	60-3004-173
Extension 3 (31.5")	60-3004-174
Extension 4 (41.5")	60-3004-175

Note that Scissor Mounting Ring Assemblies will require a base and scissors section for all sizes. Sizes from 16" to 80" will also require two or more extension sections.

B.6 Manuals

Signature Flow Meter	69-4303-070
Signature Bubbler Flow Meter	69-4333-004
TIENet 301 pH/Temperature Device	69-4303-071
TIENet 306 Sampler Interface	69-4303-072
TIENet 310 Ultrasonic Sensor	69-4313-010
Mounting Rings	60-3203-061
Flow Metering Insert	60-3234-064
Flowlink 5.1 Software	69-2543-213
Isco Open Channel Flow Measurement Handbook, 6th Ed.	60-3003-041

Signature™ Flow Meter

Appendix C Material Safety Data Sheets

This appendix provides Material Safety Data Sheets for the desiccant used by the Signature Flow Meter.

Teledyne Isco cannot guarantee the accuracy of the data. Specific questions regarding the use and handling of the products should be directed to the manufacturer listed on the MSDS.

Material Safety Data Sheet

Indicating Silica Gel

Identity (Trade Name as Used on Label)

Manufacturer : MULTISORB TECHNOLOGIES, INC. (formerly Multiform Desiccants, Inc.)	MSDS Number* : M75
Address: 325 Harlem Road Buffalo, NY 14224	CAS Number* :
Phone Number (For Information): 716/824-8900	Date Prepared: July 6, 2000
Emergency Phone Number: 716/824-8900	Prepared By* : G.E. McKedy

Section 1 - Material Identification and Information

Components - Chemical Name & Common Names (Hazardous Components 1% or greater; Carcinogens 0.1% or greater)	%*	OSHA PEL	ACGIH TLV	OTHER LIMITS RECOMMENDED
Silica Gel SiO ₂	98.0	6mg/m ³ (total dust)	10mg/m ³ (total dust)	
Cobalt Chloride	>2.0	0.05mg/m ³ (TWA cobalt metal dust & fume)	.05mg/m ³ (Cobalt, TWA)	
Non-Hazardous Ingredients				
TOTAL	100			

Section 2 - Physical/Chemical Characteristics

Boiling Point	N/A	Specific Gravity (H ₂ O = 1)	2.1
Vapor Pressure (mm Hg and Temperature)	N/A	Melting Point	N/A
Vapor Density (Air =1)	N/A	Evaporation Rate (_____ =1)	N/A
Solubility in Water	Insoluble, but will adsorb moisture.	Water Reactive	Not reactive, but will adsorb moisture.
Appearance and Odor	Purple crystals, no odor.		

Section 3 - Fire and Explosion Hazard Data

Flash Point and Methods Used	N/A	Auto-Ignition Temperature	N/A	Flammability Limits in Air % by Volume	N/A	LEL	UEL
Extinguisher Media	Dry chemical, carbon dioxide and foam can be used.						
Special Fire Fighting Procedures	Water will generate heat due to the silica gel which will adsorb water and liberate heat.						
Unusual Fire and Explosion Hazards	When exposed to water, the silica gel can get hot enough to reach the boiling point of water. Flooding with water will reduce the temperature to safe limits.						

Section 4 - Reactivity Hazard Data

STABILITY <input type="checkbox"/> Stable <input type="checkbox"/> Unstable	Conditions To Avoid	Moisture and high humidity environments.
Incompatibility (Materials to Avoid)	Water.	
Hazardous Decomposition Products	Carbon dioxide, carbon monoxide, water	
HAZARDOUS POLYMERIZATION <input type="checkbox"/> May Occur	Conditions To Avoid	None.

*Optional

Indicating Silica Gel

Section 5 - Health Hazard Data	
PRIMARY ROUTES OF ENTRY	<input type="checkbox"/> Inhalation <input type="checkbox"/> Ingestion <input type="checkbox"/> Skin Absorption <input type="checkbox"/> Not Hazardous
HEALTH HAZARDS	CARCINOGEN LISTED IN <input type="checkbox"/> NTP <input type="checkbox"/> OSHA <input type="checkbox"/> IARC Monograph <input type="checkbox"/> Not Listed Acute May cause eye, skin and mucous membrane irritation. Chronic Prolonged inhalation may cause lung damage.
Signs and Symptoms of Exposure	Drying and irritation.
Medical Conditions Generally Aggravated by Exposure	Asthma.
EMERGENCY FIRST AID PROCEDURES - Seek medical assistance for further treatment, observation and support if necessary.	
Eye Contact	Flush with water for at least 15 minutes.
Skin Contact	Wash affected area with soap and water.
Inhalation	Remove affected person to fresh air.
Ingestion	Drink at least 2 glasses of water.

Section 6 - Control and Protective Measures	
Respiratory Protection (Specify Type)	Use NIOSH approved dust mask or respirator.
Protective Gloves	Light cotton gloves. Eye Protection Safety glasses.
VENTILATION TO BE USED	<input type="checkbox"/> Local Exhaust <input type="checkbox"/> Mechanical (General) <input type="checkbox"/> Special <input type="checkbox"/> Other (Specify)
Other Protective Clothing and Equipment	None.
Hygienic Work Practices	Avoid raising dust. Avoid contact with skin, eyes and clothing.

Section 7 - Precautions for Safe Handling and Use/Leak Procedures	
Steps to be Taken if Material Is Spilled Or Released	Sweep or vacuum up and place the spilled material in a waste disposal container. Avoid raising dust.
Waste Disposal Methods	Dispose in an approved landfill according to federal, state and local regulations.
Precautions to be Taken In Handling and Storage	Cover promptly to avoid blowing dust. Wash after handling.
Other Precautions and/or Special Hazards	Keep in sealed containers away from moisture. The silica gel will readily adsorb moisture.

*Optional

Indicating Silica Gel



MATERIAL SAFETY DATA SHEET

Effective Date March 8, 2005
MSDS Number M163

Section 1 – Product and Company Information

Product Name: Silica gel, indicating, yellow

Product Use: Desiccant, absorbent
Grades: Silica gel, indicating
Synonyms: Amorphous silica gel, SiO₂, silicon dioxide (amorphous)

Company; Multisorb Technologies, Inc.
Street Address: 325 Harlem Road
City, State, Zip, Country: Buffalo, NY 14224-1893 USA

Telephone Number: (716) 824 8900 [USA] Monday - Friday (8:00 - 5:00 EDT)
Fax Number: (716) 824 4091 [USA]
Website / E-Mail : multisorb.com

Section 2 – Composition / Information on Ingredients

Component Name	CAS Number	% by Weight
Synthetic amorphous silica gel (SiO ₂)	112926-00-8	100
Phenolphthalein	77-09-08	100 ppm

While this material is not classified, this MSDS contains valuable information critical to the safe handling and proper use of this product. This MSDS should be retained and available for employees and other users of this product.

Section 3 – Hazard Identification

Emergency Overview: A yellow bead or granular material that poses little or no immediate hazard. This material is not combustible.

Potential Health Effects:

Eyes: Dust and or product may cause eye discomfort and irritation seen as tearing and reddening.

Skin: The product dust may cause drying of the skin. Silica gel may get hot enough to burn skin when it adsorbs moisture rapidly. Use an excess of water to cool the silica gel.

Ingestion: Material is not toxic and will pass through the body normally.

Inhalation: Slight irritation is possible but none is expected.

Medical Effects Generally Aggravated by Exposure: Respiratory ailments.

Chronic Effects/Carcinogenicity: May cause eye, skin and mucous membrane irritation and drying.

Section 4 – First Aid Measures

- Eyes:** Rinse the eyes well with water while lifting the eye lids. If irritation persists, consult a physician.
- Skin:** Wash affected area with soap and water.
- Ingestion:** Ingestion is unlikely, this material will pass through the body normally.
- Inhalation:** Remove the affected person to fresh air and get medical attention if necessary.
- Notes to Physician:** Not applicable

Section 5 – Fire Fighting Measures

- Flammable Properties:** Not flammable
- Flash Point:** Not applicable **Method:** Not applicable
- Flammable Limits:** Not flammable
- Lower Flammability Limit:** Not applicable
- Upper Flammability Limit:** Not applicable
- Autoignition Temperature:** Not applicable
- Hazardous Combustion Products:** Not applicable
- Extinguishing Media:** Use extinguishing media that is appropriate for the surrounding fire. Silica gel is not combustible.
- Fire Fighting Instructions:** Not combustible
- Unusual Fire and Explosion Hazards:** None

Section 6 – Accidental Release Measures

- Spill:** Sweep or vacuum up and place the spilled material in a waste disposal container. Avoid raising dust. Wash with soap and water after handling.

Section 7 – Handling and Storage

- Handling:** Avoid raising dust and minimize the contact between worker and the material. Practice good hygienic work practices.
- Storage:** Store in a cool, dry location. Keep in sealed containers away from moisture. The silica gel will readily adsorb moisture.

Section 8 – Exposure Controls/Personal Protection

Engineering Controls: Use exhaust ventilation to keep the airborne concentrations below the exposure limits.

Respiratory Protection: Use NIOSH approved respirator when the air quality levels exceed the TLV's.

Skin Protection: Light gloves will protect against abrasion and drying of the skin.

Eye Protection: Safety glasses.

Component Name	Exposure Limits		
	OSHA PEL	ACGIH TLV	Other Recommended Limits
Silica gel	TWA 20 mppcf (80 mg / m ³ % SiO ₂)	TWA 10 mg / m ³	NIOSH REL TWA 6 mg / m ³ IDLH 3000 mg / m ³
Phenolphthalein	Not Applicable	Not Applicable	Not Applicable

Section 9 – Physical and Chemical Properties

Appearance:	Yellow beads or granules	Vapor Density:	Not applicable
Odor:	None	Boiling Point:	4046° F (2230° C)
Physical State:	Solid bead	Melting Point:	3110° F (1710° C)
PH:	Not applicable	Solubility:	Insoluble in water
Vapor Pressure:	Not applicable	Specific Gravity:	2.1

Section 10 – Stability and Reactivity

Stability: Stable

Conditions to avoid: Moisture and high humidity environments.

Incompatibility: Water, fluorine, oxygen difluoride, chlorine trifluoride

Hazardous Decomposition Products: None

Hazardous Polymerization: Will not occur

Section 11 – Toxicological Information

This product and its components are not listed on the NTP or OSHA Carcinogen lists.

Animal Toxicology Tests for DOT Hazard classification
(Tests Conducted on finely ground silica gel)
1 - hour LC₅₀ (rat) > 2 mg / l
48 - hour oral LD₅₀ (rat) est. > 31,600 mg / kg
48 - hour dermal LD₅₀ (rabbit) est. > 2,000 mg / kg
Considered an ocular irritant

Human Toxicology Silica gel is a synthetic amorphous silica not to be confused with crystalline silica. Epidemiological studies indicate low potential for adverse health effects. In the activated form, silica gel acts as a desiccant and can cause a drying irritation of the mucous membranes and skin in cases of severe exposure. Multisorb Technologies Inc. knows of no medical conditions that are abnormally aggravated by exposure to silica gel. The primary route of entry is inhalation of dust.

Section 12 – Ecological Information

Not known to have any adverse effect on the aquatic environment. Silica gel is insoluble and non-toxic.

Section 13 – Disposal Information

Disposal Information If this product as supplied becomes a waste, it does not meet the criteria of a hazardous waste as defined under the Resource Conservation and Recovery Act (RCRA) 40 CFR 261. Materials of a hazardous nature that contact the product during normal use may be retained on the product. The user of the product must identify the hazards associated with the retained material in order to assess the waste disposal options. Dispose according to federal, state and local regulations.

Section 14 – Transportation Information

U.S. Department of Transportation Shipping Name: Not classified as a hazardous material. Not regulated.

Section 15 – Regulatory Information (Not meant to be all inclusive - selected regulations represented)

TSCA Listed: Yes

DSL/NDSL (Canadian) Listed: Yes

OSHA: TWA 20 mppcf (80 mg / m³ % SiO₂) for Silica gel

NIOSH: REL TWA 6 mg / m³ IDLH 3,000 mg / m³ for silica gel
Animal tests conducted in 1976 - 1978. 18 month exposure at 15 mg / m³ showed silica deposition in respiratory macrophages and lymph nodes, minimum lung impairment, no silicosis.

ACGIH: TLV - 10 mg / m³ for Silica gel

DOT: Not classified as a hazardous material.

HMIS – Hazardous Materials Identification System

HMIS Rating	
Health	0
Flammability	0
Reactivity	0

0 - minimal hazard, 1 - slight hazard, 2 - moderate hazard, 3 - serious hazard, 4 - severe hazard

This MSDS was prepared by: George E. Mckedy
Senior Applications Development Specialist
Multisorb Technologies, Inc.

This data and recommendations presented in this data sheet concerning the use of our product and the materials contained therein are believed to be correct but does not purport to be all inclusive and shall be used only as a guide. However, the customer should determine the suitability of such materials for his purpose before adopting them on a commercial scale. Since the use of our products is beyond our control, no guarantee, expressed or implied, is made and no responsibility assumed for the use of this material or the results to be obtained therefrom. Information on this form is furnished for the purpose of compliance with Government Health and Safety Regulations and shall not be used for any other purposes. Moreover, the recommendations contained in this data sheet are not to be construed as a license to operate under, or a recommendation to infringe, any existing patents, nor should they be confused with state, municipal or insurance requirements, or with national safety codes.

Signature™ Flow Meter

Index

Numerics

- 301 pH/temperature device, 4-10
- 306 sampler interface, 4-10
- 308 analog current output, 4-12
- 310 ultrasonic sensor, 4-10
- 330 bubbler module, 4-10
 - installation, 5-12
- 4-20 mA, 4-12

A

- accessories, B-1
- adjust display, 1-7
- adjust levels, 2-20, 3-20
- administration, 2-27
 - display license information, 2-28
 - display signature information, 2-28
 - language options, 2-28
 - restore to factory defaults, 2-28
 - sensor diagnostics, 2-28
 - set new passcode, 2-28
 - update firmware, 2-28
- alarm
 - local, 2-23
 - SMS & server, 2-23
- alarms, 2-23
- alphanumerics, 2-8
- analog output, 2-23, 4-12
 - programming, 4-13

B

- battery backup, 4-4
- browser window, 2-6
- Bubble Line
 - Extensions, 3-18
 - Flume Fittings, 3-18
 - High-Velocity Flow Streams, 3-17
 - Open Channel Installation, 3-19
 - Stilling Wells, 3-18
- bubbler, 4-10

C

- calibration, 2-20, 3-20
- case board, 3-1
 - layout, 3-2
- CDMA, 4-23
- cellular modems, 4-23
 - installation, 4-24
 - setup, 4-26

- character grid, 2-8
- cleaning, 5-1
- clock, 2-18
- compatible equipment, 1-3
- compliance, 2-32
- components, 1-5
- conditions, 2-21
- configure measurements, 2-11
- configure options, 2-17
 - adjust, 2-20
 - data storage/push, 2-22
 - equation/trigger setup, 2-21
 - flow settings, 2-19
 - measurement setup, 2-18
 - outputs, 2-23
 - reports/history, 2-26
 - reset totalizers, 2-26
 - sampler, 2-23
 - site, 2-18
- connecting TIENet devices, 3-7
- connecting via Flowlink, 2-2
- connecting via USB, 2-2
- connections, 3-1, 3-2, 3-3
 - power, 3-10
- contact Teledyne Isco, 5-17
- control panel
 - display, 1-7
 - keypad, 1-7, 2-1
 - LED indicator, 1-7
- cord-grip, 3-5

D

- data
 - compliance, 1-3, 2-32
 - download, 2-31
 - dump, 2-30
 - events, 1-3
 - export, 2-32
 - integrity, 1-3, 2-30, 2-31, 2-32
 - push, 2-22
 - storage, 2-22
- default settings, 2-28
- default units, 2-18
- description, 1-1
- desiccant, 5-2
 - external, 5-3
 - internal, 5-3
- device info, 2-5
- diagnostics, 2-28

- display, 1-7
- display contrast, 1-7
- display equipment info, 2-28
- display license info, 2-28
- drop down menus, 2-9
- dump data, 2-30

E

- equations, 2-21
- equipment options, 4-1
- ethernet modem, 4-18
 - configuration, 4-21
 - MAC address, 4-22
- event viewer, 2-31
 - export data, 2-32
- events, 1-3
- expansion box, 4-11

F

- factory defaults, 2-28
- firmware, 2-28, 2-30
- firmware updates, 5-1
- flash drive, 2-29, 5-1
- flow conversions, 2-19
- flow measurement, 2-19
- Flowlink, 2-31, 4-18
 - browser, 2-6
 - connecting, 2-2
 - devices, 2-5
 - event viewer, 2-31
 - program window, 2-6
 - site info, 2-4

G

- GSM, 4-24

H

- hardware scan, 2-11
- hardware setup, 2-10
 - Modbus input, 2-13
 - Modbus output, 2-16
 - modem, 2-16
 - SDI-12, 2-12
 - smart sensor, 2-11
- histograph, 2-7
- history, 2-26
- home display, 2-18
- home screen, 2-7

I

- Installation
 - Bubble Line, 3-16
- installation, 3-1
 - mounting, 3-11
 - outdoor, 3-12
- interior, 3-1
- introduction, 1-1

K

- keypad, 1-6, 1-7, 2-1

L

- language, 2-28
- level adjustment, 2-7
- level calibration, 3-20

M

- maintenance, 5-1
 - bubbler replacement, 5-12
 - cleaning, 5-1
 - desiccant, 5-2
 - firmware updates, 5-1
- Material Safety Data Sheets, C-1
- measurement setup
 - flow input, 2-18
 - level input, 2-18
 - volume input, 2-18
- measurements, 2-11
- mechanical totalizer, 4-6
- menus, 2-9
- Modbus input setup, 2-13
- Modbus output setup, 2-16
- modem
 - cellular, 4-23
 - ethernet, 4-18
- modem setup, 2-16
- mounting options, 3-11
- MSDS, C-1

O

- off-screen content, 2-8
- optional equipment, 4-1
- options, 1-3, B-1
 - battery backup, 4-4
 - cellular modems, 4-23
 - ethernet modem, 4-18
 - expansion box, 4-11
 - Flowlink, 4-18
 - mechanical totalizer, 4-6
 - reference port tubing kit, 4-16
 - TIENet devices, 4-10
- order parts, A-1, B-1
- outputs
 - alarm, 2-23
 - analog, 2-23, 4-12

P

- passcode, 2-28
- pH/temperature device, 4-10
- port holes, 3-1, 3-3
 - fittings, 3-5
 - plugs, 3-6
- power, 3-10
 - battery backup, 4-4
 - wiring, 3-10

- program window, 2-6
- programming, 2-8
 - administration, 2-27
 - alphanumerics, 2-8
 - analog output, 4-13
 - cellular modem, 4-26
 - character grid, 2-8
 - configure, 2-17
 - general rules, 2-8
 - hardware setup, 2-10
 - menus, 2-9
 - navigation, 2-8
 - pull down menus, 2-9
 - scrolling, 2-8
 - top menu, 2-9
 - USB options, 2-29
- pull down menus, 2-9
- pushed data, 2-22

Q

- quick start, 1-2

R

- reference port tubing kit, 4-16
- repairs, 5-17
- replacement parts, A-1
- report view, 2-7
- reports, 2-26, 2-30
 - export, 2-32
 - verification, 2-32
- reset, 5-16
- reset passcode, 2-28

S

- safety, 1-v
- sampler interface, 2-23, 4-10
- scan, 2-11
- scrolling, 2-8
- SDI-12, 2-12
- security, 1-3
- select operation, 2-9
- sensor diagnostics, 2-28
- sensor differences, 2-11
- servicing, 5-1, 5-17
- setup and programming, 2-1
- shield, 3-12
- shortcuts, 2-7
 - histograph, 2-7
 - level adjustment, 2-7
 - report view, 2-7
- site information, 2-4
- site name, 2-18
- site setup, 2-18
- smart sensor setup, 2-11
- software, 2-2, 4-18
- specifications, 1-7
- system reset, 5-16

T

- Technical Service, 5-17
- technical specifications, 1-7
- TIENet devices, 4-10
 - 301 pH/temperature device, 4-10
 - 306 sampler interface, 2-23, 4-10
 - 308 analog current output, 4-12
 - 310 ultrasonic level sensor, 4-10
 - 330 bubbler module, 4-10
 - connecting, 3-7
 - expansion box, 4-11
- totalizer reset, 2-26
- triggers, 2-21
- typing characters, 2-8

U

- ultrasonic level sensor, 4-10
- units, 2-18, 2-28
- update firmware, 2-28, 2-30
- USB drivers, 2-2
- USB options, 2-29
 - dump data, 2-30
 - none of the above, 2-31
 - retrieve text reports, 2-30
 - update firmware, 2-30
- user interface, 2-1
 - browser, 2-2, 2-6
 - Flowlink, 2-2
 - keypad, 2-1

V

- verification, 2-30, 2-32
- verification tool, 2-32

产品中有毒有害物质或元素的名称及含量

Name and amount of Hazardous Substances or Elements in the product

部件名称 Component Name	有毒有害物质或元素 Hazardous Substances or Elements					
	铅 (Pb)	汞 (Hg)	镉 (Cd)	六价铬 (Cr(VI))	多溴联苯 (PBB)	多溴二联苯 (PBDE)
线路板 Circuit Boards	X	O	O	O	O	O
显示 Display	X	O	O	O	O	O
接线 Wiring	O	O	O	O	X	O
内部电缆 Internal Cables	O	O	O	O	X	O
主电源线 Line Cord	O	O	O	O	X	O
直流电机 DC Motor	X	O	O	O	X	O
小键盘 Keypad	O	O	O	O	X	O
接头 Connectors	O	O	X	O	O	O
电池 Battery	X	X	X	O	O	O
电磁阀 Solenoid valve	X	O	O	O	X	O

产品中有毒有害物质或元素的名称及含量：Name and amount of Hazardous Substances or Elements in the product

O: 表示该有毒有害物质在该部件所有均质材料中的含量均在ST/ 标准规定的限量要求以下。

O: Represent the concentration of the hazardous substance in this component's any homogeneous pieces is lower than the ST/ standard limitation.

X：表示该有毒有害物质至少在该部件的某一均质材料中的含量超出ST/ 标准规定的限量要求。

(企业可在此处，根据实际情况对上表中打“X”的技术原因进行进一步说明。)

X: Represent the concentration of the hazardous substance in this component's at least one homogeneous piece is higher than the ST/ standard limitation.

(Manufacturer may give technical reasons to the “X”marks)

环保使用期由经验确定。

The Environmentally Friendly Use Period (EFUP) was determined through experience.

生产日期被编码在系列号码中。前三位数字为生产年(207 代表 2007 年)。随后的一个字母代表月份：

A 为一月，B 为二月，等等。

The date of Manufacture is in code within the serial number. The first three numbers are the year of manufacture (207 is year 2007) followed by a letter for the month. "A" is January, "B" is February and so on.

DECLARATION OF CONFORMITY



Application of Council Directive: 004/108/EC -The EMC Directive
002/96/EC – The WEEE Directive
006/95/EC– The Low Voltage Directive

Manufacturer's Name: Teledyne Isco
Manufacturer's Address: 4700 Superior
Lincoln, Nebraska 68504 USA
P.O. Box 82531, Lincoln, NE 68501

Equipment Type/Environment: Equipment for Light Industrial/Commercial Environments

Trade Name/Model No: Signature with optional 310 Ultrasonic sensor, 330 Bubbler, 306 Sampler Interface, 301 Ph & Temperature Interface, 308 Analog Output, Ethernet Modem

Year of Issue: 2011

Harmonized Standards Conformity is Declared: EN 61010-1 2nd edition Safety Requirements for Electrical Equipment for Measurement, Control, and Laboratory Use
EN 61326-1:2003 EMC Requirements for Electrical Equipment for Measurement, Control, and Laboratory Use
EN60529 Special Protection offered by the Signature's Enclosure: IP-66

Standard	Description	Severity Applied	Performance Criteria
EN61000-4-2	Electrostatic Discharge	4kV contact discharge 8kV air discharge	A
EN61000-4-3	Radiated RF Immunity	80 mHz to 2.7GHz, 80% AM at 1kHz 10V/m to 1GHz, 3V/m to 2.7GHz	A
EN61000-4-4	Electrical Fast Transient	2kV on AC lines 1kV on I/O lines	A
EN61000-4-5	Surge on AC Lines	2kV common mode, 1kV differential mode	A
EN61000-4-6	Conducted RF on AC lines and I/O lines	150 kHz to 80 mHz, 3V rms, 80% modulated	A
EN61000-4-11	Voltage Dips/Interruptions	100% drop, 0.5 cycle	A
CISPR11/ EN 55011	RF Radiated Emissions	Group 1, Class A Industrial, Scientific, and Medical Equipment	Pass
EN61000-3-2, 3-3	Power Factor Harmonics, Flicker		Pass

The undersigned, hereby declares that the design of the equipment specified above conforms to the above Directive(s) and Standards as of December 30, 2011.

USA Representative

Vikas V. Padhye Ph, D
Vice President and General Manager
4700 Superior Street
Lincoln, Nebraska 68504
Phone: (402-464-0231
FAX: (402-464-0318



60-4302-021

Teledyne Isco One Year Limited Factory Service Warranty*

This warranty exclusively covers Teledyne Isco instruments, providing a one-year limited warranty covering parts and labor.

Any instrument that fails during the warranty period due to faulty parts or workmanship will be repaired at the factory at no charge to the customer. Teledyne Isco's exclusive liability is limited to repair or replacement of defective instruments. Teledyne Isco is not liable for consequential damages.

Teledyne Isco will pay surface transportation charges both ways within the 48 contiguous United States if the instrument proves to be defective within 30 days of shipment. Throughout the remainder of the warranty period, the customer will pay to return the instrument to Teledyne Isco, and Teledyne Isco will pay surface transportation to return the repaired instrument to the customer. Teledyne Isco will not pay air freight or customer's packing and crating charges. This warranty does not cover loss, damage, or defects resulting from transportation between the customer's facility and the repair facility.

The warranty for any instrument is the one in effect on date of shipment. The warranty period begins on the shipping date, unless Teledyne Isco agrees in writing to a different date.

Excluded from this warranty are normal wear; expendable items such as charts, ribbon, lamps, tubing, and glassware; fittings and wetted parts of valves; and damage due to corrosion, misuse, accident, or lack of proper maintenance. This warranty does not cover products not sold under the Teledyne Isco trademark or for which any other warranty is specifically stated.

No item may be returned for warranty service without a return authorization number issued by Teledyne Isco.

This warranty is expressly in lieu of all other warranties and obligations and Teledyne Isco specifically disclaims any warranty of merchantability or fitness for a particular purpose.

The warrantor is Teledyne Isco, 4700 Superior, Lincoln, NE 68504, U.S.A.

*** This warranty applies to the USA and countries where Teledyne Isco does not have an authorized dealer. Customers in countries outside the USA, where Teledyne Isco has an authorized dealer, should contact their Teledyne Isco dealer for warranty service.**

Before returning any instrument for repair, please call, fax, or e-mail the Teledyne Isco Service Department for instructions. Many problems can often be diagnosed and corrected over the phone, or by e-mail, without returning the instrument to the factory.

Instruments needing factory repair should be packed carefully, and shipped to the attention of the service department. Small, non-fragile items can be sent by insured parcel post. **PLEASE BE SURE TO ENCLOSE A NOTE EXPLAINING THE PROBLEM.**

Shipping Address: Teledyne Isco - Attention Repair Service
4700 Superior Street
Lincoln, NE 68504 USA

Mailing Address: Teledyne Isco
PO Box 82531
Lincoln, NE 68501 USA

Phone: Repair service: (800) 775-2965 (lab instruments)
(866) 298-6174 (samplers & flow meters)
Sales & General Information: (800) 228-4373 (USA & Canada)

Fax: (402) 465-3001

Email: IscoService@teledyne.com



February 28, 2012 P/N 60-1002-040 Rev G



