

# LaserFlow®

A NON-CONTACT SENSOR FOR  
OPEN CHANNEL FLOW MEASUREMENT



# You know with LaserFlow!

Acquire precise readings with the only **non-contact** flow measurement sensor to read **below the surface**.

The LaserFlow non-contact sensor offers the most accurate and cost-effective way to monitor water flow in most open channel applications. It's suitable for small and large pipes, streams, rivers, sewers, stormwater, and wastewater. With real-time data and customizable alerts, you can monitor your systems for effectiveness and failures...without leaving your office.\*

Do you need to report the influent and effluent of your treatment or manufacturing facility? You have the data at your fingertips.

Why is one storm channel reading lower than others after the same storm event? You will know if you need to send a crew to look for clogs.

Is there a channel that remains too high after others have returned to normal? Perhaps an engineering study to determine adequate sizes for that drainage basin.

No more driving out to the field to check on status or descending into manholes to check if systems are clear and functioning...see it all from your desk.\*

**What's happening out there?  
With LaserFlow, you know!**

\*When used with compatible logging and communication equipment.



## NON-CONTACT

With the nature of non-contact flow measurement, the LaserFlow can accurately measure water velocity without contacting and disturbing water flow. No water contacting the sensor means there is little need for constant cleaning and maintenance. The LaserFlow sensor will not collect dirt and debris under normal flow conditions because it is above the channel. This minimizes the need for your personnel to be exposed to hazardous locations.

## SUBSURFACE

Water flow is affected by many factors including channels with unusual shapes, flumes, weirs, and pipes, leading to different patterns to the velocity of flow. The construction materials of a channel has a big effect on the flow as well. Materials such as PVC, ceramic, metals, cement, and natural ground have different friction coefficients, which will also affect the velocity. The LaserFlow sensor monitors the fluctuating water level and finds the optimal velocity point below the surface. It is here the most accurate readings are registered. Maximum precision is achieved by taking velocity measurements at single or multiple points, producing an accurate mean velocity reading. With multi-point measurements, the effects of a non-uniform flow velocity profile in the channel is minimized by performing a horizontal scan at different depths. This advancement eliminates the need for time consuming manual profiling prior to installation.

## ACCURATE MEASUREMENT REGARDLESS OF FLOW CONDITIONS

This results in highly reliable, repeatable flow measurements that you can rely on. From bidirectional flow, varying flow speeds and liquid levels, including submerged conditions, the LaserFlow continues to perform accurately by automatically adjusting to these changing conditions.

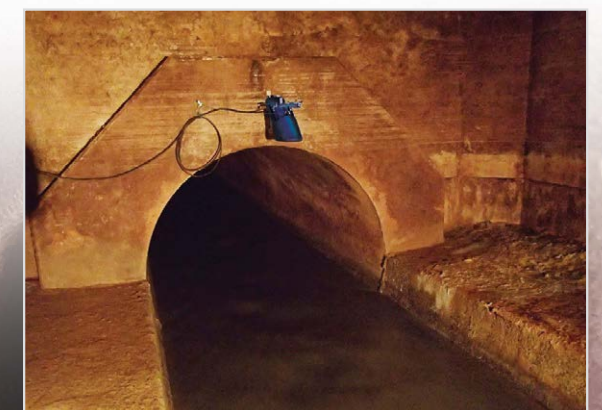

# SMALL & LARGE PIPE



# How can the LaserFlow be so Accurate?

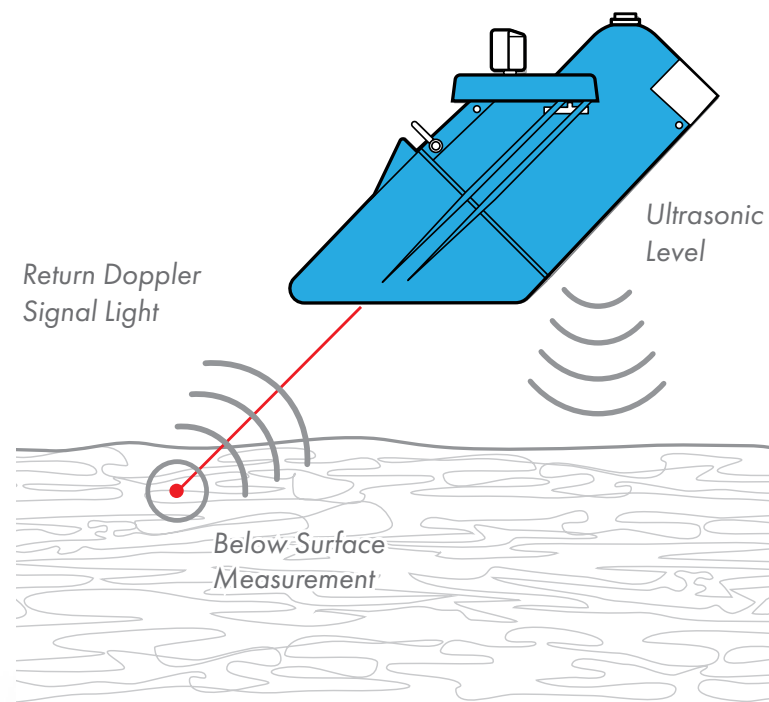

The revolutionary development of the LaserFlow sensor is how the velocity measurement is collected. By measuring the depth of the water, and knowing the dimensions of the channel, the wetted area can be calculated.

With the LaserFlow, this depth is measured using an ultrasonic sensor that bounces a sound wave off the surface of the water to determine the depth of the channel.

By using the level measurement information, the LaserFlow sensor focuses a laser beam below the surface of the water. The frequency of the returned light will shift from the transmitted signal. This shift, called Doppler shift, is directly proportional to the velocity of the water and is how the velocity is measured.

Furthermore, the laser can be focused in several different locations below the surface, and within the flow stream, to collect information from different points capturing the true velocity component.

## TYPICAL CHANNEL FLOW VELOCITY PATTERNS

Each channel has its own unique velocity profile which can be affected by the surface tension and channel shape, causing slower movement along the sides and faster through the center.

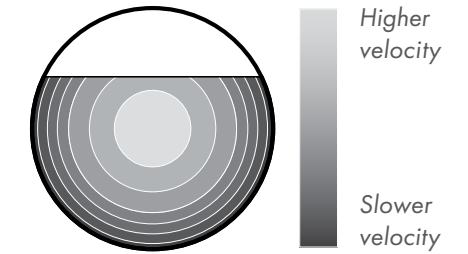

## SELF-LEARNING ALGORITHMS & ADVANCED FEATURES

The LaserFlow sensor is engineered to do the work so you don't have to. The adaptive focus option enables the LaserFlow sensor to perform a vertical scan above and below the standard focus point, then adjust the focus to the point with the best signal strength. Optimal signal strength reduces measurement error and produces clear results, regardless of the application. This is ideal when there is a change in elevation (less than 3") between the incoming pipe and the manhole invert or there is a standing wave or debris at the level measuring point.

In applications when the flow profile is possibly affected by incoming flow from the side of the pipe or a bend in the pipe, the peak detect option provides accurate results. Peak detect scans five points across the user-defined row to locate the peak velocity at a single depth. In turn, a true velocity measurement point is identified in changing flow conditions.

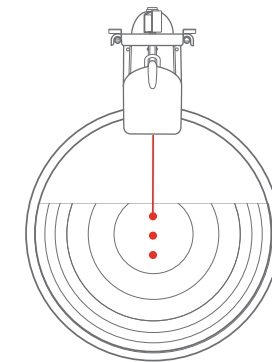

**Adaptive Focus**  
Vertical scan for maximum Doppler power 3 inches above and below focal point.

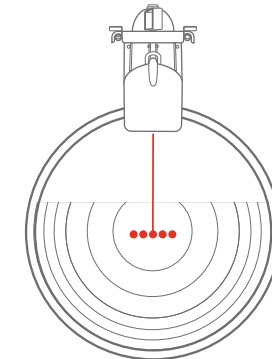

**Peak Detection**  
Scans across user defined row to find the peak velocity.



# RIVER & STREAM



# Why you need LaserFlow!

## DURABLE CONSTRUCTION

Like all Teledyne ISCO products, the LaserFlow sensor is durably constructed for lasting performance. Due to the non-contact nature of the LaserFlow, interaction with flow is not common in normal conditions. However, in surcharged flow conditions, the LaserFlow's rugged construction and submersible enclosure with IP68 ingress protection will keep the electronics safe. The angled body of the LaserFlow allows condensation to easily run off, not interfering with level measurement. Composed mainly of ABS and SST, the LaserFlow is chemical, heat, and corrosion resistant.

## MINIMAL COST OF OWNERSHIP

The construction of the LaserFlow offers lasting durability, while the above water installation limits the need for routine cleaning, maintenance and site visits, saving time, money, and resources.

## EFFORTLESS DATA COLLECTION

With Teledyne ISCO's remote communication options and Flowlink® software you can monitor data, anywhere, anytime, on any device.



## EASE OF CALIBRATION

Velocity measurement at single or multiple points below the surface eliminates the need for manual profiling. Ultrasonic signal strength validates level measurement while the Doppler power information of the return signal ensures an accurate velocity reading and allows the user insight into changing pipe hydraulics over time.

## WIDEST APPLICATION RANGE

Both the LaserFlow and the LaserFlow Ex can be used in a wide range of applications or situations:

- Flow measurement for CSO, SSO, I&I, SSEs, CMOM, and other sewer monitoring programs
- Wastewater treatment plant influent, process, and effluent flow measurement
- Industrial process and discharge flow measurement
- Stormwater conveyance and outfall
- Shallow flow measurement in varying pipe sizes
- Irrigation canals and channels
- LaserFlow Ex can be installed in hazardous areas

## EASY INSTALLATION & MAINTENANCE

The Teledyne ISCO hardware makes installation easy. Removal and redeployment is simple from street level. Mounted above the water, the LaserFlow can eliminate confined space entry for maintenance.



# STORMWATER



# Unique Applications? No Problem.

## SLOW OR HIGH VELOCITY

Smooth surface flow conditions from low velocities are no challenge for LaserFlow. The capability to measure below the surface eliminates the need for motion on the liquid's surface to generate a return signal. This is a very challenging application that only LaserFlow can meet, measuring velocities as low as 0.5 feet per second to as rapid as 15 feet per second.

## LOW OR HIGH LEVELS

Low water levels can be difficult to measure for many non-contact sensors. LaserFlow can accurately measure velocities in levels as shallow as 0.5 inches. During high level conditions, the sensor can provide readings right up to the bottom of the sensor with zero deadband.

## HAZARDOUS LOCATIONS

The LaserFlow Ex is the first non-contact sensor that is certified for hazardous areas classified as Class 1, Div 1, Zone 0 and ATEX category 1G. You get the same accuracy as the LaserFlow, but is suitable for hazardous environments such as:

- Wastewater Collection Systems
- Combined Sewer Overflows
- Sanitary Sewer Overflows
- Industrial Discharge
- Water Resource Recovery Facilities
  - Influent
  - Effluent
  - Bypass Channels
  - Chlorine Contact
  - UV Disinfection Channels

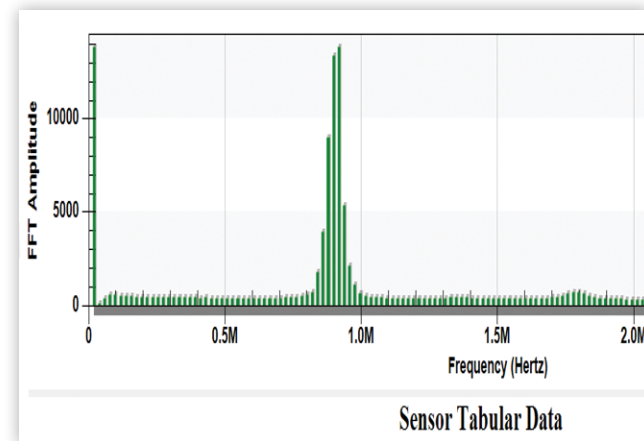

Superior signal-to-noise ratio is the key that allows the laser to measure slow or low flow, clean water conditions.

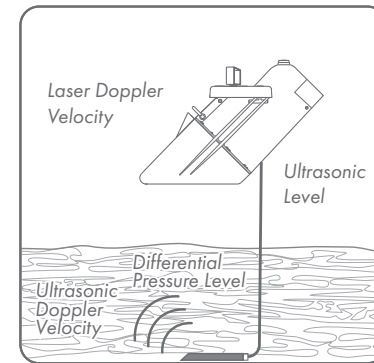
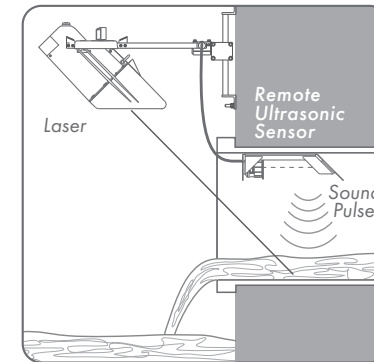
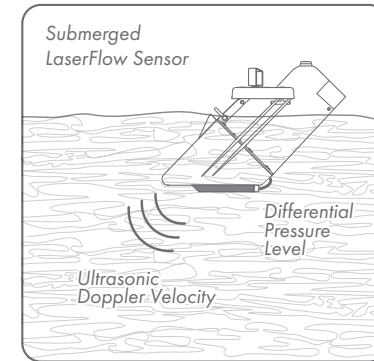

## CONTINUOUS MEASUREMENTS IN SUBMERGED CONDITIONS

During submerged conditions, when water reaches the LaserFlow, the optional bottom-mounted 350 AV sensor seamlessly takes over the flow rate measurement. The surcharge sensor measures velocity using continuous wave Doppler area velocity (AV) technology and level by a differential pressure sensor. During surcharged conditions, the AV sensor measures precise flow over a large area, and is not limited to the area around the sensor.

## ACCURATE MEASUREMENT TO DIFFERENT ELEVATIONS

In applications such as a free-falling outfall or drop manhole, the level of the water under the sensor will differ from the level at the velocity measurement point. If the difference in elevation is more than three inches, a Teledyne ISCO remote ultrasonic sensor may be installed above the velocity measurement point so that both measurement points reference the same elevation.

To accommodate unique site requirements, various mounting hardware is available for use with the LaserFlow sensor and remote ultrasonic sensor.

## REDUNDANT MEASUREMENT FOR CRITICAL SITES

When redundant flow measurement is required for critical monitoring sites, an additional sensor can be added to the LaserFlow sensor or flowmeter. The addition of the TIENet 310 Ultrasonic provides redundant level measurement, whereas the addition of the TIENet 350 Area Velocity sensor provides redundant level, velocity and flow measurement. No additional power source is required for these additional sensors. With this flexibility, redundant measurements with different measurement technologies can be easily performed at the same location.



# COLLECTION SYSTEMS



# Diagnostic Tools, A Game Changer

## DIAGNOSITICS

Sooner or later, all water monitoring devices will experience some form of extreme conditions. The LaserFlow is no exception; however, thanks in part to its rugged, submergible enclosure, and ability to compensate for misalignments, the LaserFlow can adjust its programming to continue taking readings in any conditions. If condensation starts to build up on the window of your LaserFlow, an internal heater will activate to clean the window.

Ultrasonic signal strength validates level measurement while the Doppler power information of the return signal ensures an accurate velocity reading and allows insight into changing pipe hydraulics over time. All diagnostic data can be accessed from the LaserFlow by using our Flowlink® software.

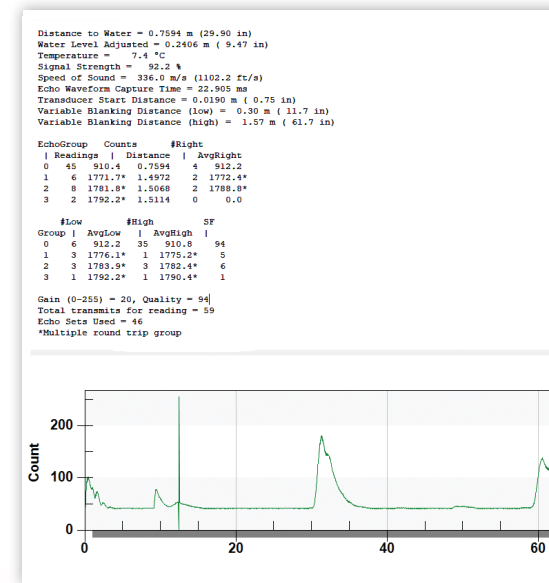
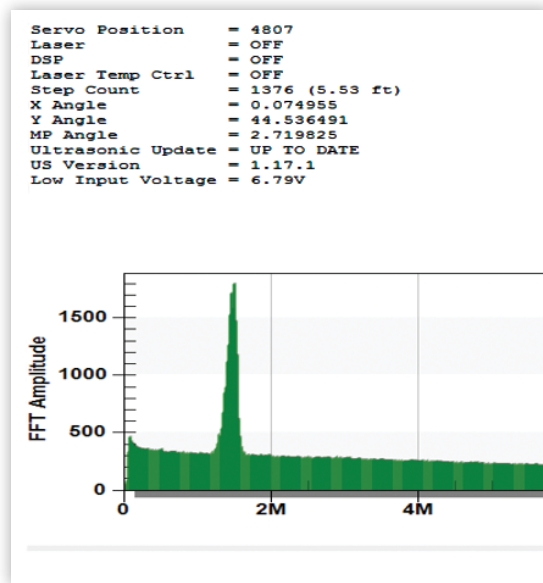

Diagnostic report shows the sensor is level and showing strong Doppler (left) and Ultrasonic (right) signal returns.

## SELECT THE RIGHT CONFIGURATION OPTION

From industrial applications to municipal manhole installations, the LaserFlow offers versatile configuration options, giving you the flexibility to monitor flow in numerous open channel applications. For these applications you can use one of three Teledyne ISCO flowmeters with the LaserFlow:

- **2160 LaserFlow Module**  
Battery powered logger to collect historical data

- **Signature® Flowmeter**  
AC or DC powered flowmeter for permanent sites

- **Signature® Portable Flowmeter**  
Battery or solar powered flowmeter for remote sites

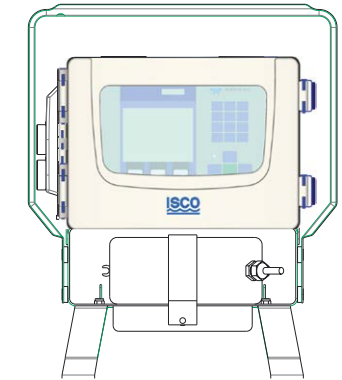
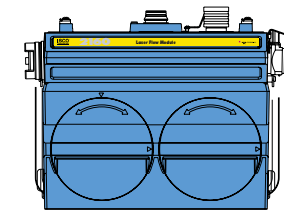

## Flowlink®

Flowlink® provides the tools to manage all your flow monitoring data. The software is specifically designed for desktop computers in the office and notebook computers in the field. To collect data, the software communicates via USB connectivity, Ethernet and cellular modem (CDMA or GSM). Once the data is retrieved, the software has built in tools for evaluating site conditions, data analysis, and reporting without having to make a site visit.



Photo Credit: Dan Maulder, RS Hydro

# WASTEWATER TREATMENT