

# PRODUCT GUIDE

A guide to products for the Oil & Gas,  
Petrochemical, Chemical and Power segments.

**Measurement and Control**

**Temperature Sensors**

**Grab Sampling Systems**

**Electronic Instrumentation**

**SOR**  
CONTROLS GROUP

An SOR 1800 Series  
Pressure Transmitter  
installed at an oil and gas  
facility in Malaysia.



### Who we are

SOR Controls Group is a global leader in the design and manufacture of measurement and control devices under the brands of SOR Measurement and Control, SSi Temperature Sensors, SENSOR Sampling Systems and PYRAGON Electronic Instrumentation. SOR Controls Group actively serves all sectors of the process industry with particular strengths in the oil & gas, petrochemical, chemical and power segments. We support a network of sales and service personnel capable of addressing customer requirements in any geographic market around the world.

### One of the Best Machine Shops in America

Our manufacturing facilities include more than 90,000 square feet of vertically integrated production capability and we are proud of having our Lenexa, Kansas machine shop voted one of the top 10 in the United States by the American Machinist magazine. With decades of experience manufacturing measurement and control products, we have designs for thousands of unique applications around the world.

### Engineered to Order with Off-the-Shelf Speed

The exact product you need delivered when you need it. It's what SOR Controls Group has built its reputation on since 1946. We have enjoyed the distinction of meeting the challenges of the process industries for many years. We provide the most reliable electronic and electromechanical pressure, level, temperature, flow instruments and grab sampling systems.

### Customer Service is Our Focus

SOR Controls Group is dedicated to reducing product lead times and has LEAN initiatives in place to continuously improve the quality and delivery of products we provide to you. We know that no two applications are exactly the same. We work one-on-one with customers all over the world to meet their individual application challenges and obstacles. While this Product Guide provides the specifications and options available for SOR Controls Group products, our global Representatives organization and factory Sales Engineers also stand ready to help you get the right device for the job. Just give us a call.



200 Team Members Worldwide



Sales Offices in Beijing, Dubai, Chennai, Lenexa, Houston and Rochester



Manufacturing Locations in Lenexa, KS, Houston, TX and Rochester, NY



Exports into 75 Countries

# Table of Contents

<b>Pressure</b>	Switches _____	2
	Differential Switches _____	4
	Compact Transmitters _____	6
	Conventional Transmitters _____	7
<b>Temperature</b>	Switches _____	8
	Sensors _____	9
<b>Electronic</b>	Temperature Transmitters _____	10
	Alarm Modules & Isolators _____	10
<b>Level</b>	Switches _____	11
	Transmitters _____	13
	Indicators _____	14
	Engineered Bypass Chambers _____	14
	Flushing Rings _____	14
<b>Flow</b>	Switches _____	15
	Transmitters _____	15
<b>Nuclear Qualified</b>	Switches _____	16
<b>Systems</b>	Sampling Systems _____	17
<b>Engineered to Order</b>	Engineering & Manufacturing Capabilities _____	19
	Diaphragm Seals _____	21
	Classifications & Environmental Protection _____	22
	Certifications & Approvals _____	23
	General Applications _____	24







## NN

**Weatherproof**  
(Pressure/Vacuum/  
Compound)



30 inHg vac to 7000 psi  
1 bar vac to 480 bar

**3 YEAR WARRANTY**

- Low cost
- Set point adjustment with calibrated scale
- Pivot seal version for high pressure available
- For more information, see [Catalogs 216 & 219](#)



## RN

**Weatherproof, Terminal Block Connections**  
(Pressure/Vacuum/  
Compound)



30 inHg vac to 7000 psi  
1 bar vac to 480 bar

**3 YEAR WARRANTY**

- Low cost
- Set point adjustment with calibrated scale
- Terminal block connections
- For more information, see [Catalogs 216 & 219](#)



## L

**Explosion Proof**  
(Pressure/Vacuum/  
Compound)



30 inHg vac to 7000 psi  
1 bar vac to 480 bar

**3 YEAR WARRANTY**

- Low cost
- Set point adjustment with calibrated scale
- Explosion proof rated as an outlet box
- For more information, see [Catalogs 216 & 219](#)



## B3

**Explosion Proof, UL/CSA/ATEX**  
(Pressure/Vacuum/  
Compound)



30 inHg vac to 7000 psi  
1 bar vac to 480 bar

**3 YEAR WARRANTY**

- Terminal block connections
- Set point adjustment with calibrated scale
- Set point adjustment without declassification of hazardous area
- For more information, see [Catalogs 216 & 219](#)



## BIG HERMET

**Explosion Proof, Hermetically Sealed**  
(Pressure/Vacuum/  
Compound)



30 inHg vac to 7000 psi  
1 bar vac to 480 bar

**3 YEAR WARRANTY**

- Complete pressure range offering
- Hermetically sealed snap switch(es)
- Set point adjustment with calibration scale
- Set point adjustment without declassification of hazardous area
- For more information, see [Catalogs 455 & 219](#)



# SOR PRESSURE SWITCHES

Today's SOR Pressure Switches are the descendants of the original Static "O" Ring® mechanical pressure switches that set industry standards more than 50 years ago. They are field-proven, low cost process instruments for use as either primary or redundant pressure or flow monitoring applications in a wide variety of industries.



**MINI-HERMET**  
Explosion Proof,  
Hermetically Sealed  
(Pressure/Compound)



30 inHg vac to 7000 psi  
1 bar vac to 480 bar  
3 YEAR WARRANTY

- Compact, explosion proof switch
- Hermetically sealed snap switch(es)
- Set point adjustment without declassification of hazardous area
- For more information, see [Catalogs 456 & 219](#)



**V1**  
Weatherproof  
(Pressure/Vacuum/  
Compound)



30 inHg vac to 4000 psi  
1 bar vac to 275 bar  
3 YEAR WARRANTY

- Two independent switches sharing same housing and port
- Dual set points available
- Set point adjustment with calibrated scale
- Adjustable dead band on some models
- For more information, see [Catalogs 217 & 281](#)



**V2**  
Explosion Proof,  
Hermetically Sealed  
(Pressure/Vacuum/  
Compound)



30 inHg vac to 4000 psi  
1 bar vac to 275 bar  
3 YEAR WARRANTY

- Two independent switches sharing same housing and port
- Dual set points available
- Hermetically sealed snap switch(es)
- Adjustable dead band on some models
- Set point adjustment without declassification of hazardous area
- For more information, see [Catalogs 217 & 281](#)



**SUB-MINI-HERMET**  
Explosion Proof,  
Hermetically Sealed  
(Pressure)



8 to 200 psi  
0.5 to 14 bar  
3 YEAR WARRANTY

- Low cost explosion proof switch
- Hermetically sealed snap switch(es)
- Set point adjustment without declassification of hazardous area
- For more information, see [Catalog 987](#)





## NN

**Weatherproof**  
(Single diaphragm)



3 to 500 psid  
0.2 to 35 bar

3 YEAR WARRANTY

- Low cost
- Set point adjustment with calibrated scale
- For more information, see [Catalog 468](#)



## RN

**Weatherproof, Terminal Block Connections**  
(Single diaphragm)



3 to 500 psid  
0.2 to 35 bar

3 YEAR WARRANTY

- Terminal block connections
- Set point adjustment with calibrated scale
- For more information, see [Catalog 468](#)



## L

**Explosion Proof**  
(Single diaphragm)



3 to 500 psid  
0.2 to 35 bar

3 YEAR WARRANTY

- Low cost
- Set point adjustment with calibrated scale
- Explosion proof rated as an outlet box
- For more information, see [Catalog 468](#)



## B3

**Explosion Proof, UL/CSA/ATEX**  
(Single diaphragm)



3 to 500 psid  
0.2 to 35 bar

3 YEAR WARRANTY

- Terminal block connections
- Set point adjustment with calibrated scale
- Set point adjustment without declassification of hazardous area
- For more information, see [Catalog 468](#)



## BIG HERMET

**Explosion Proof, Hermetically Sealed**  
(Single diaphragm)



3 to 500 psid  
0.2 to 35 bar

3 YEAR WARRANTY

- Hermetically sealed snap switch(es)
- Set point adjustment with calibration scale
- Set point adjustment without declassification of hazardous area
- For more information, see [Catalog 468](#)

# SOR DIFFERENTIAL PRESSURE SWITCHES

Accuracy, multi-use flexibility and the ability to match the instrument to the application distinguish SOR differential pressure switches from off-the-shelf products. Standard models are available in weatherproof and explosion proof configurations and can include an external set point adjustment mechanism for simplified calibration.







**MINI-HERMET**  
Explosion Proof,  
Hermetically Sealed  
(Single diaphragm)



3 to 500 psid  
0.2 to 35 bar

3 YEAR WARRANTY

- Compact low cost explosion proof switch
- Hermetically sealed snap switch(es)
- Set point adjustment without declassification of hazardous area
- For more information, see [Catalog 468](#)



**RB**  
Weatherproof  
(Dual diaphragm,  
opposed piston)



0.5 to 1000 psid  
35 mbar to 70 bar

3 YEAR WARRANTY

- Separate pressure ports to customize material and size
- Terminal block connections
- Set-point adjustment with calibrated scale
- For more information, see [Catalog 386](#)



**S**  
Explosion Proof  
(Dual diaphragm,  
opposed piston)



0.5 to 1000 psid  
35 mbar to 70 bar

3 YEAR WARRANTY

- Separate pressure ports to customize material and size
- Set-point adjustment with calibrated scale
- For more information, see [Catalog 386](#)



**102 & 103**  
Explosion Proof,  
Hermetically Sealed  
(High-static operation)



7 inwc to 2500 psid  
18 mbar to 175 bar

3 YEAR WARRANTY

- High static pressures at low differential set points
- Negligible temperature and/or static influence
- Hermetically sealed snap switch(es)
- Weatherproof version available
- For more information, see [Catalog 388](#)

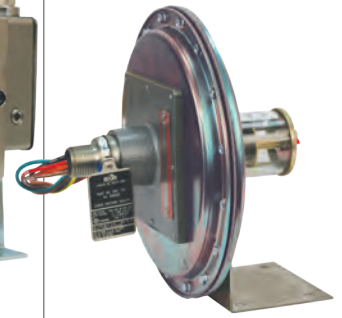

**107**  
Explosion Proof,  
Hermetically Sealed  
(Low range)



0 to 40 inwc  
0 to 1000 mmwc

3 YEAR WARRANTY

- Highly accurate low range for draft applications
- Set point adjustment with calibrated scale
- Hermetically sealed snap switch(es)
- Weatherproof version available
- For more information, see [Catalog 459](#)

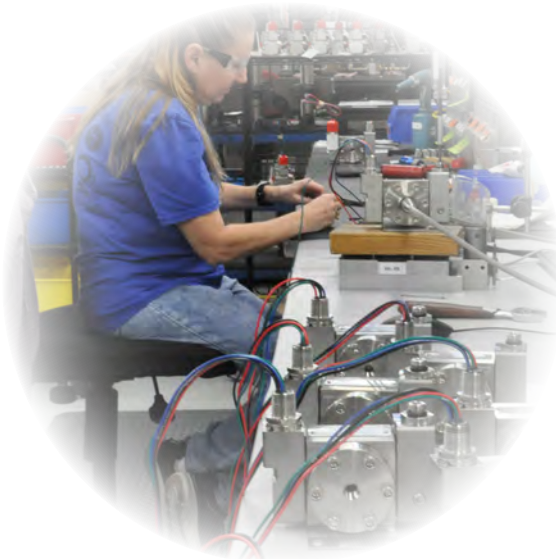



**815PT**  
Explosion Proof  
(Gauge and Absolute)



0-5 to 0-30,000 psi  
0-0.34 to 0-2068 bar

3 YEAR WARRANTY

- Modbus RTU (RS-485)
- Compact, 316 stainless steel enclosure
- Stainless steel sensor
- +/-0.25% (URL) continuous output accuracy
- HART® 7 with 4-20mA or 1-5 VDC output
- 9-way configurable solid state switch output
- LCD explosion proof display option available
- For more information, see [Catalog 1806](#)



**815DT**  
Explosion Proof  
(Differential)



5 to 500 psid  
0-0.34 to 0-35 bar

3 YEAR WARRANTY

- Modbus RTU (RS-485)
- Compact, 316 stainless steel enclosure
- Stainless steel sensor
- +/-0.25% (URL) continuous output accuracy
- HART® 7 with 4-20mA or 1-5 VDC output
- 9-way configurable solid state switch output
- LCD explosion proof display option available
- For more information, see [Catalog 1806](#)



**815LT**  
Submersible  
Hydrostatic Pressure  
(Gauge)

7 to 575 ft. w.c.  
(2.1 to 175.5 mw.c.)

3 YEAR WARRANTY

- IP68 housing submersible up to 1200 ft.
- Cage option to protect sensors from solids and prevent build-up
- Vent tube for reference to atmospheric pressure
- Modbus RTU (RS-485)
- Compact, 316 stainless steel enclosure
- +/-0.25% (URL) continuous output accuracy
- HART® 7 with 4-20mA or 1-5 VDC output
- 9-way configurable solid state switch output
- LCD explosion proof display option available
- For more information, see [Catalog 1735](#)

# SOR COMPACT PRESSURE TRANSMITTERS

“Set it and forget it” reliability makes SOR pressure transmitters perfect for applications where space is tight. Our stainless steel construction stands up to the rigors of hostile environments and hazardous locations. SOR transmitters have adjustable ranges and are available with 4-20mA, 1-5VDC, HART® 7 and Modbus RTU protocol outputs.





### 1800PT

(Gauge with Standard Over Pressure)



-5.8 psi to +5.8 psi thru  
-14.5 psi to +5802 psi

3 YEAR WARRANTY

- 4-20mA output and optional HART®, 1-5VDC low power or Modbus output
- ±0.075% accuracy (F.S.)
- Aluminum explosion proof housing
- Standard push-buttons for setup
- Integral LCD display
- EMC (EMI/RFI) protection
- ATEX / IECEx intrinsically safe and flameproof approvals
- CSA explosion proof certification
- For more information, see [Catalog 1906](#)



### 1800PR

(Piezoresistive Gauge Pressure)



-1 psi to +1 psi thru  
-14.5 psi to +14,504 psi

3 YEAR WARRANTY

- 4-20mA output and optional HART®, 1-5VDC low power or Modbus output
- ±0.2% accuracy (F.S.)
- Aluminum explosion proof housing
- Standard push-buttons for setup
- Integral LCD display
- EMC (EMI/RFI) protection
- ATEX / IECEx intrinsically safe and flameproof approvals
- CSA explosion proof certification
- For more information, see [Catalog 1906](#)



### 1800DP

(Differential Pressure)



-0.87 psid to +0.87 psid  
-72.5 psid to +1450 psid

3 YEAR WARRANTY

- 4-20mA output and optional HART®, 1-5VDC low power or Modbus output
- ±0.075% accuracy (F.S.)
- Aluminum explosion proof housing
- Standard push-buttons for setup
- Integral LCD display
- EMC (EMI/RFI) protection
- ATEX / IECEx intrinsically safe and flameproof approvals
- CSA explosion proof certification
- For more information, see [Catalog 1906](#)



### 1800DM & RM

(Differential Pressure with Diaphragm Seal)  
Direct and Remote Mount



-5.8 psid to +5.8 psid  
-72.5 psid to +145 psid

3 YEAR WARRANTY

- 4-20mA output and optional HART® or Modbus output
- Accuracy (F.S.) ±0.075% DM, ±0.2% RM
- Aluminum explosion proof housing
- Standard push-buttons for setup
- Integral LCD display
- EMC (EMI/RFI) protection
- ATEX / IECEx intrinsically safe and flameproof approvals
- CSA explosion proof certification
- For more information, see [Catalog 1906](#)



### 1800 SERIES

MF2, MF3, MF5  
(Manifolds)

MF2 2-valve manifold  
MF3 3-valve manifold  
MF5 5-valve manifold

- MF2 usable with any instrument with 1/2"NPT connection
- MF3 and MF5 only usable with 1800 Series differential
- For more information, see [Catalog 1906](#)



**SOR**

CONVENTIONAL

# PRESSURE TRANSMITTERS

The 1800 Series pressure transmitters are well suited for intrinsically safe applications or conventional transmitter installations. The 1800 Series transmitters utilize an advanced monosilicon pressure sensor and incorporate an encapsulation technology to achieve exceptional mechanical and thermal isolation.



### NN

**Weatherproof**  
(Direct or remote mount)



-60° to 1000°F  
-51° to 540°C

3 YEAR WARRANTY

- Low Cost
- Set point adjustment with calibrated scale
- For more information, see [Catalog 220](#)



### RN

**Weatherproof, Terminal Block Connections**  
(Direct or remote mount)



-60° to 1000°F  
-51° to 540°C

3 YEAR WARRANTY

- Terminal block connections
- Set point adjustment with calibrated scale
- For more information, see [Catalog 220](#)



### B3

**Explosion Proof, UL/CSA/ATEX**  
(Direct or remote mount)



-60° to 1000°F  
-51° to 540°C

3 YEAR WARRANTY

- Terminal block connections
- Set point adjustment with calibrated scale
- Set point adjustment without declassification of hazardous area
- For more information, see [Catalog 220](#)



### BIG HERMET

**Explosion Proof Hermetically Sealed**  
(Direct or remote mount)



-60° to 1000°F  
-51° to 540°C

3 YEAR WARRANTY

- Hermetically sealed snap switch(es)
- Set point adjustment with calibrated scale
- Set point adjustment without declassification of hazardous area
- For more information, see [Catalog 220](#)



### MINI-HERMET

**Explosion Proof Hermetically Sealed**  
(Direct or remote mount)



-60° to 1000°F  
-51° to 540°C

3 YEAR WARRANTY

- Hermetically sealed snap switch(es)
- Set point adjustment without declassification of hazardous area
- For more information, see [Catalog 220](#)



# SOR TEMPERATURE SWITCHES

When you need a quick response, choose SOR temperature switches. They consistently lead the industry in sales year after year because of their small dead band ranges and legendary reliability.

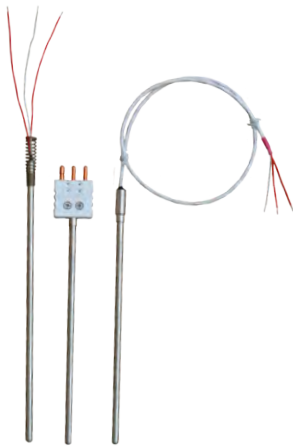

## RTDS

1 YEAR WARRANTY

- Versatile design can be used in various applications
- Standard sheath material is 316SS, other materials available
- Industrial style can be inserted into an existing thermowell
- Type 1150 with plug for direct termination
- Type 1250 with wire extended leads for remote termination
- Temperature ranges up to 1475°F (800°C) and cryogenic applications down to -328°F (-200°C)
- Field adjustable style can be cut to length down to 3" minimum
- All RTDs receive 100% functionality and insulation resistance testing
- Field adjustable and industrial styles supplied with heavy duty spring
- For more information, see [Catalog 1667](#)

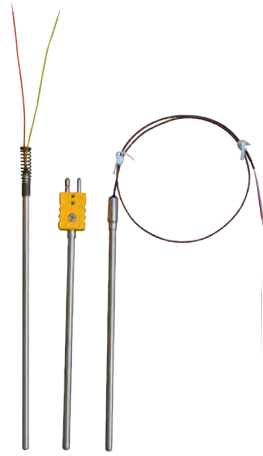

## THERMOCOUPLES

1 YEAR WARRANTY

- Versatile design can be used in various applications
- Standard sheath material is 316SS, other materials available
- Industrial style can be inserted into an existing thermowell
- Type 1100 with plug for direct termination
- Type 1200 with wire extended leads for remote termination
- Calibration types J, K, T, E, N, R, S, B available
- Field adjustable style can be cut to length down to 3" minimum
- Industrial and field adjustable styles supplied with heavy duty spring
- For more information, see [Catalog 1667](#)



## THERMOWELLS & SAMPLE PROBES

1 YEAR WARRANTY

- Manufactured to specifications and/or to fit existing RTD or thermocouple
- Threaded, Flanged, Socket Weld, Sanitary, Weld-in and Van Stone connections available
- Offered with straight, tapered or step-down well shank
- Pipe thermowell configurations also available
- Can be constructed in a wide variety of common and exotic materials
- For more information, see [Catalog 1667](#)



## SENSOR ASSEMBLIES

1 YEAR WARRANTY

- 316SS sheath material standard
- Sensor protection with optional thermowell/ tube well constructed to your specifications
- Optional connection heads suited for general purpose or explosion proof applications
- Multipoint sensor assemblies provide more complete temperature profiles for multiple measuring points required over broad range
- Vast customization capability with wide array of accessories
- Specialty sensors available, such as Surface Mount, Pipe Clamp, Tubeskin, Oil Seal and more
- For more information, see [Catalog 1667](#)



## TRANSMITTERS

3 YEAR WARRANTY

- Accepts RTD and Thermocouple inputs
- Full access to all features while in operation
- Optional LCD display with loop or battery-powered, suited for general purpose and explosion proof applications
- All types are programmable
- Transmitters are available with bluetooth or NFC for configuration
- 4-20mA output, optional HART communications protocol
- For more information, see [Catalog 1667](#)

# SSi TEMPERATURE SENSORS

SSi Temperature Sensors manufactures a complete line of thermocouple elements, RTD sensors, thermowells, industrial assemblies and specialty temperature sensors. Products include multipoint temperature sensors, sanitary RTDs, high temperature furnace thermocouples, surface/tubeskin thermocouples and so much more to suit a wide variety of industrial applications and OEM markets with both demanding and general purpose temperature measurement requirements.





## 2800 SERIES

Universal T/C & RTD  
Temperature  
Transmitters

4 YEAR WARRANTY

- Self-contained, programmable
- Built in display
- -40 to +85°C ambient installation
- RFI protected
- Accuracy: <1 °C or °F



## 100 SERIES

Two Wire  
Temperature  
Transmitters  
(Hockey Puck Style)

4 YEAR WARRANTY

- Temperature, T/C and RTD
- AC current and AC Voltage
- VDC and mVDC
- Hz (speed and rotation)
- -30°C to +85°C ambient installation



## 200/300 SERIES

DIN Mounted  
Temperature  
Transmitters

4 YEAR WARRANTY

- 2 and 3 wire output powered
- Current and voltage outputs
- Temperature, T/C and RTD
- AC current and AC voltage
- Hz (speed and rotation)
- -30°C to +85°C ambient installation,



## ALARM MODULES

Critical & Dedicated  
Point Monitoring

4 YEAR WARRANTY

- Inputs - VAC, AAC, VDC, mADC, T/C RTD
- Adjustable time delay
- Latching action
- Adjustable deadband
- 10A, SPDT relay output



## ISOLATORS

Solves Ground  
Loop Problems

4 YEAR WARRANTY

- DIN and hockey puck packaging
- Input loop powered
- 2 and 3 Wire output loop power
- Isolated prime power
- Quick shipment available

# PYRAGON ELECTRONIC INSTRUMENTATION

PYRAGON designs and manufactures a complete line of industrial temperature transmitters, alarms, isolators and signal conditioners. We offer OEM custom solutions for many instrumentation needs.

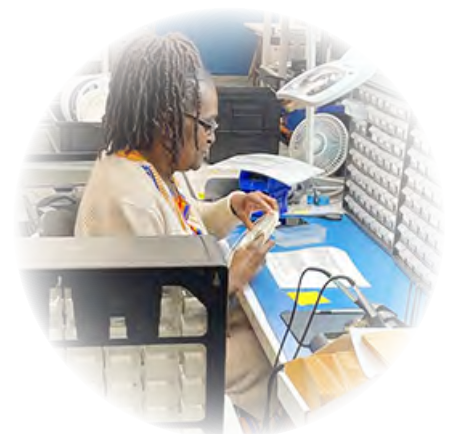



**100 SERIES,  
741-743, 802**  
Flanged Chamber



vac to 3600 psi  
vac to 248 bar

-65° to 1200°F  
-54° to 649°C

5 YEAR WARRANTY

- Serviceable flanged chamber
- Stainless steel switching mechanism for harsh atmospheres
- Electromechanical & pneumatic switching mechanisms offered
- For more information, see **Catalog 912**



**200 SERIES,  
740, 804**  
Sealed Chamber



vac to 3728 psi  
vac to 257 bar

-65° to 1200°F  
-54° to 649°C

5 YEAR WARRANTY

- Low cost sealed chamber
- Stainless steel switching mechanism for harsh atmospheres
- Electromechanical & pneumatic switching mechanisms offered
- For more information, see **Catalog 912**



**700 SERIES,  
730 & 750 SERIES**  
Top Mounted  
Displacer



vac to 1000 psi  
vac to 69 bar

-65° to 650°F  
-54° to 232°C

5 YEAR WARRANTY

- Available in 1, 2 or 3-stage switching
- Narrow and wide differential with floating roof capabilities
- Stainless steel switching mechanism for harsh atmospheres
- Electromechanical & pneumatic switching mechanisms offered
- For more information, see **Catalog 912**



**300 SERIES**  
Top Mounted Float



vac to 750 psi  
vac to 51 bar

-65° to 1200°F  
-54° to 649°C

5 YEAR WARRANTY

- Available in 1- or 2-stage switching
- Stainless steel switching mechanism for harsh atmospheres
- Electromechanical & pneumatic switching mechanisms offered
- For more information, see **Catalog 912**



**400 SERIES**  
Side Mounted Float



vac to 1250 psi  
vac to 86 bar

-65° to 1200°F  
-54° to 649°C

5 YEAR WARRANTY

- Horizontal side mounted float
- Stainless steel switching mechanism for harsh atmospheres
- Electromechanical & pneumatic switching mechanisms offered
- For more information, see **Catalog 912**



# SOR LEVEL SWITCHES

SOR level switches have earned a long-time reputation for their high quality, rugged construction and reliable performance under the most demanding applications. All level switches are individually built with strict attention to detail to meet the exact specifications of your process.



**108 & 208**  
Steam Trap Chamber



vac to 2248 psi  
vac to 155 bar  
-65° to 1200°F  
-54° to 649°C

5 YEAR WARRANTY

- Serviceable flanged or sealed chamber
- Stainless steel switching mechanism for harsh atmospheres
- Electromechanical & pneumatic switching mechanisms offered
- For more information, see **Catalog 912**



**1500 SERIES**  
Compact Level



vac to 5000 psi  
vac to 345 bar  
-40° to 400°F  
-40° to 204°C

5 YEAR WARRANTY

- Economical side and top mounted versions available
- Stainless steel switch housing for harsh atmospheres
- Low cost sealed chamber available
- Explosion proof
- For more information, see **Catalog 500**



**1710, 2210**  
Compact Level



vac to 1799 psi  
vac to 124 bar  
-40° to 750°F  
-40° to 399°C

5 YEAR WARRANTY

- Stainless steel switching mechanism for harsh atmospheres
- Low cost sealed chamber available
- Explosion proof or "Quick release" threaded cover
- For more information, see **Catalogs 864, 1414**



**701, 711, 721,  
712 & 722**  
Single & Dual Point  
Ultrasonic



0 to 2000 psi  
0 to 135 bar  
-40° to 250°F  
-40° to 121°C

3 YEAR WARRANTY

- Low cost
- No calibration required
- Relay and current shift (8/16mA) output available
- 316SS sensor
- Dual set point available
- For more information, see **Catalog 1145**



**651 & 681**  
Single Point RF  
**660 SERIES**  
Multipoint RF



0 to 2000 psi  
0 to 135 bar  
-100° to 400°F  
-73° to 204°C

3 YEAR WARRANTY

- Low cost
- Single point switch for alarm applications
- Relay and current shift (8/16mA) output available
- Up to four points level indication for both high and low level alarms
- Adjustable differential feature provides for pump control
- A variety of probe configurations meet most application conditions
- For more information, see **Catalog 1100**







**815LT**  
Submersible  
Hydrostatic Pressure  
(Gauge)

7 to 575 ft. w.c.  
(2.1 to 175.5 mw.c.)

3 YEAR WARRANTY

- IP68 housing submersible up to 1200 ft.
- Cage option to protect sensors from solids and prevent build-up
- Vent tube for reference to atmospheric pressure
- Modbus RTU (RS-485)
- Compact, 316 stainless steel enclosure
- +/-0.25% (URL) continuous output accuracy
- HART® 7 with 4-20mA or 1-5 VDC output
- 9-way configurable solid state switch output
- LCD explosion proof display option available
- For more information, see [Catalog 1735](#)



**815DT**  
Explosion Proof  
(Differential)

0-5 to 500 psid  
0.34 to 0-35 bar

3 YEAR WARRANTY

- Modbus RTU (RS-485)
- Compact, 316 stainless steel enclosure
- Stainless steel sensor
- +/-0.25% (URL) continuous output accuracy
- HART® 7 with 4-20mA or 1-5 VDC output
- 9-way configurable solid state switch output
- LCD explosion proof display option available
- For more information, see [Catalog 1806](#)



**670**  
SERIES  
RF

Up to 19.5 ft.  
(5.9m)

3 YEAR WARRANTY

- Continuous level measurement transmitter
- Measurement range up to 19.5 ft.
- Loop-powered, intrinsically safe 4-20mA output
- A variety of probe configurations meet most application conditions
- For more information, see [Catalog 1100](#)



# SOR LEVEL TRANSMITTERS

SOR level transmitters continuously sense the liquid level in tanks and deliver an analog signal proportional to the level. The output can be connected to a programmable logic controller, computer, remote display or relay module to display and/or control the liquid level in the tank. Some models also include a switch output.

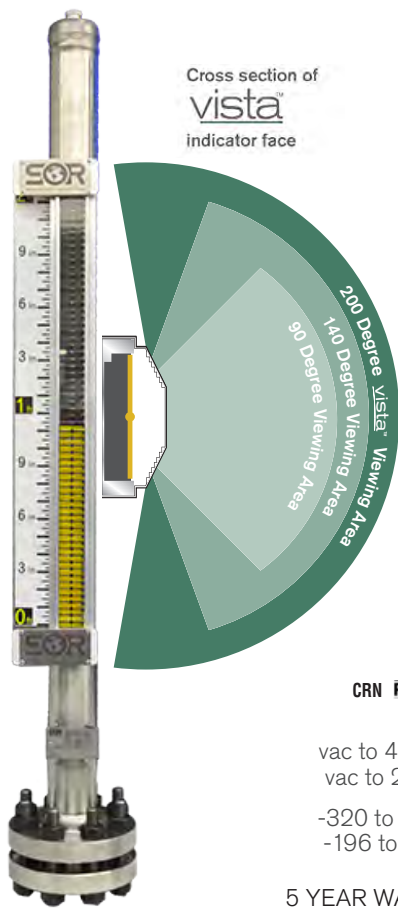

Cross section of  
**vista™**  
indicator face

### 1100 SERIES Magnetic Level Indicators

CRN PED

vac to 4000 psi  
vac to 276 bar  
-320 to 1000°F  
-196 to 538°C

5 YEAR WARRANTY

- 200° viewing angle with **vista™** indicator
- Forward viewing distance of 250 feet (76 meters)
- Chambers designed to ANSI/ASME B31.1/B31.3 guidelines
- Schedule 10 & 40 316/316L stainless steel construction standard, schedule 80+ and other materials available
- ASME Section IX and AWS qualified welding system
- Dimensional drawings available at quotation
- No pressurized floats
- Interface detection capability
- NACE, CRN and PED certifications available
- A wide variety of indicator flag colors are available
- High temperature and Cryogenic designs suitable for extreme applications
- Extensive list of auxiliary instrumentation available
- For more information, see [Catalog 1596](#)



### 1000 SERIES Engineered Bypass Chambers

CRN PED

vac to 5000 psi  
vac to 345 bar  
-320 to 1200°F  
-196 to 649°C

5 YEAR WARRANTY

- Completely customizable design
- Chambers designed to ASME B31.1/B31.3 guidelines, with certificates available
- 2-8" chamber size with Schedule 10 – XXS wall thickness in a wide variety of materials
- ASME Section IX and AWS qualified welding system
- Hydrotested @ 1.5 MAWP standard
- NACE, CRN and PED certifications available
- Inspections and testing certifications done to SOR standard or your specific requirements
- Extensive list of auxiliary instrumentation available
- For more information, see [Catalog 1884](#)



### 1010FR Flushing Rings

1/2", 3/4", 1", 1-1/2", 2", 3", 4"  
Standard Ring Sizes

CS or 316SS Standard  
Ring Construction

5 YEAR WARRANTY

- Universal fit with any device on the market
- Can be supplied with welded valve assemblies
- Available in a wide variety of standard and exotic materials
- NACE option available
- Inspections and testing certifications done to SOR standard or your specific requirements
- For more information, see [Catalog 1737](#)



# LEVEL INDICATORS

SOR level indicators are a proven method for streamlining liquid level measurement. Not only do they give exceptional visual indication, they also eliminate the need for armored sight glass instruments – simplifying piping systems and allowing for multiple measurements without unnecessary complications.





**T21**  
Thermal Differential



-100° to 392°F  
-70° to 200°C

Gases up to 500 ft/second  
Liquids up to 5 ft/second

1 YEAR WARRANTY

- Wide operating process temperature range
- Designed for liquid and gas flow applications
- Removable, plug-in electronics board
- Self-heating sensor design
- For more information, see [Catalog 1021](#)



**900 SERIES**  
Vane Operated



vac to 1480 psi  
vac to 102 bar

-15° to 250°F  
-26° to 121°C

5 YEAR WARRANTY

- Stainless steel switching mechanism for harsh atmospheres
- All ASTM materials construction
- Flow monitoring for a wide range of pipe sizes and specific gravities
- For more information, see [Catalog 672](#)



**1520**  
OEM



vac to 5000 psi  
vac to 345 bar

-40 to 400°F  
-40 to 204°C

5 YEAR WARRANTY

- All stainless steel construction
- Standard product rating of 1500 psi @ (-40°F to 400°F), 100 bar @ -40°C to 204°C
- For more information, see [Catalog 499](#)



**815DT**  
Explosion Proof  
(Differential)



5 to 500 psid  
0-0.34 to 0-35 bar

3 YEAR WARRANTY

- Modbus RTU (RS-485)
- Compact, 316 stainless steel enclosure
- Stainless steel sensor
- +/-0.25% (URL) continuous output accuracy
- HART® 7 with 4-20mA or 1-5 VDC output
- 9-way configurable solid state switch output
- LCD explosion proof display option available
- For more information, see [Catalog 1806](#)



# SOR FLOW SWITCHES & TRANSMITTERS

SOR flow switches and transmitters have proven to be workhorses in the process instrumentation industry. They are ruggedly built to exacting standards and provide long-lasting service.



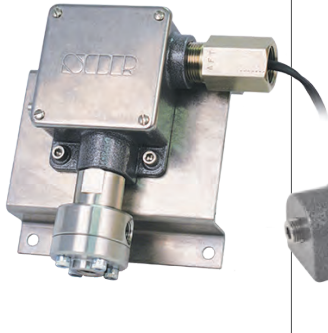

**131 & 141**  
Differential Pressure  
Switches

5" wcd to 180 psid  
13 mbard to 12.4 bard

1 YEAR WARRANTY

- 1E qualified
- Long-term stability
- Negligible temperature effect
- HELB tested to 30Mrad
- Quick delivery
- For more information see [Catalog 1291](#)



**N6, RT, TA**  
Pressure Switches

30" HgV to 1750 psi  
1000 mbarv to 120 bar

1 YEAR WARRANTY

- Carbon and stainless steel housing for HELB tested to 31Mrad min.
- Ductile iron housing for LOCA tested to 186Mrad min.
- Threaded cover with double environmental seal
- Vent connection provided if needed
- Terminal block connections if needed
- Engineered to meet your specifications
- For more information see [Catalog 651](#)



**N6, RT, TA**  
Temperature Switches

40° to 375°F  
5° to 190°C

1 YEAR WARRANTY

- Carbon, ductile iron, and stainless steel housing for HELB tested to 31Mrad min.
- Threaded cover with double environmental seal
- Vent connection provided if needed
- Terminal block connections if needed
- Engineered to meet your specifications
- For more information see [Catalog 651](#)



**SOR**  
**NUCLEAR**  
**QUALIFIED PRODUCTS**

SOR custom engineers nuclear-qualified pressure, temperature, differential and vacuum switches. Our engineering expertise is specifically targeted to meet the unique demands of the nuclear power generation industry and provide solutions.



**BBSS**  
**Basic Bottle**  
**Sampling System**

ATEX & PED

150 psig max operating  
 System designed to 2000 psig

135°F max without cooler  
 800°F max with cooler & graphoil valve packing

1 YEAR WARRANTY

- Simple, flow-thru valve design
- Zero dead volume
- Individually replaceable needles dual and CONCENTRIC
- SENSOR Needle Evacuation System (NES) available
- For more information see **Catalog 1675**



**PIBSS**  
**Pressure Isolating**  
**Bottle Sampling**  
**System**

ATEX & PED

2000 psig max operating  
 System designed to 3000 psig

135°F max without cooler  
 800°F max with cooler & graphoil valve packing

1 YEAR WARRANTY

- Guarantees repeatable sample volume
- Zero dead volume
- Individually replaceable needles dual and CONCENTRIC
- Suitable for high operating pressures
- SENSOR Needle Evacuation System (NES) standard
- For more information see **Catalog 1680**



**LGSS & VSS**  
**Liquefied Gases**  
**& Vapors**  
**Sampling Systems**

ATEX & PED

1440 psig mas (LGSS)  
 2000 psig max (VSS)

350°F maximum

1 YEAR WARRANTY

- Safe, simple methodology for sampling high pressure liquefied gasses and vapors
- Single handle operation
- Local pressure indication for safe and effective sampling
- Sight glass ensures safe cylinder outage and local indication of flow
- Ability to depressurize quick connects before removing sample cylinder
- For more information see **Catalog 1681**



**ISS**  
**Inline**  
**Sampling System**

ATEX & PED

1440 psig max  
 150 psig max when sampling without collection cylinder option

800°F with graphoil valve packing

1 YEAR WARRANTY

- Available in wide variety of piping materials and end connections
- Suitable for high temperature, high viscosity service
- Available with open tube "stinger" or traditional needles
- SENSOR Needle Evacuation System (NES) available
- For more information see **Catalog 1679**



**RSS**  
**RAM**  
**Sampling Systems**

ATEX & PED

1440 psig max  
 150 psig max when sampling without collection cylinder option

800°F with graphoil valve packing

1 YEAR WARRANTY

- Available in wide variety of materials and end connections
- Suitable for high temperature, high viscosity service
- Available with open tube "stinger" or traditional needles
- SENSOR Needle Evacuation System (NES) available
- For more information see **Catalog 1756**



**SENSOR**  
**SAMPLING SYSTEMS**

SENSOR Sampling Systems provide a representative sample that is safe to both the operator and the environment. Our systems are designed to meet Leak Detection Repair (LDAR), Maximum Achievable Control Standards (MACT) and Volatile Organic Compounds (VOC) emission standards. Since no two sampling systems are exactly alike, each of our products is engineered to order.



## DTSS

### Gas Sampling and Spot Testing System

2000 psig max pressure  
350°F max temperature  
(higher pressure and temperature ratings available)

1 YEAR WARRANTY

- Proven design is safe and reliable
- Can be used for any gas stream where impurities are present and spot testing of their presence is required
- Accommodates standard Draeger®, Sensidyne® and GASTEC® detection tube at detection port on sample station
- Plate-mounted shelf accommodates portable pump while operator draws the sample through the detection tube
- No need to retrieve or transport delicate Tedlar bags for sample analysis
- No risk of losing sample while transporting to the lab, since the sample is analyzed in the field, which allows faster feedback to operations for process corrections
- Higher pressures can be safely lowered before sampling occurs regardless of process pressure
- Lab sample can be retrieved at the same time as spot testing to verify spot test for accuracy
- Includes an additional safety measure in a pressure relief valve on the detector loop in the event pressure reduction fails
- Standard materials of construction are 316SS, PTFE/PFA and Viton® with options for Monel®, Hastelloy® C276 and Kalrez® o-rings



## HPSS

### Heavy Products Sampling System

Collect hot, heavy products (such as resid, asphalt, hot tar, gas oil, resins, slurries, surfactants and emulsions) while maintaining personnel safety

1 YEAR WARRANTY

- Non-insulated enclosure to prevent splashing and burns
- Steam purge sample path independent of process flow to remove residual and prevent plugging
- Removable/replaceable cartridge system to allow easy repair and/or replacement without removing the valve base and pipe spool
- Twist Lock Purge Adapter to contain and direct purged residual directly to enclosure drain eliminating mess
- Unique 3-way valve ensures steam is kept hot and condensate free
- For more information, see [Catalog 1772](#)



## IVSS

### Inline Valve Sampling System

232 psig max pressure  
350°F max temperature

1 YEAR WARRANTY

- Spring-loaded handle that automatically closes off after releasing
- Weep hole above packing to provide early warning if packing begins to fail
- Interchangeable adapters can be used to allow various bottle types with thread-in or needle configuration
- Throttle handle to control the bottle fill rate
- Lockable handle with insertion pin to lock out operation while performing maintenance
- Wafer or Inline type design to fit any new or existing piping configurations
- Standard 316SS and available in HC276 to handle corrosive chemicals
- Needle/bottle adapters for vertical pipe installations.



## TFSS

### Tank Farms Sampling System

50 psig max pressure  
120°F max temperature

1 YEAR WARRANTY

- Can be utilized in areas where there is no existing fast loop
- Utilizes a high viscosity BBSS Flow-Thru Sample Valve to accommodate more viscous fluids and line sizes up to 3/4"
- Hand Pump allows material to be circulated through the system in order to achieve a representative sample without flowing product to a drain
- Flow totalizer to indicate total volume circulated through system to ensure lines from various levels of the tank have been properly flushed
- Standard materials of construction is 316SS, pump is cast iron and flow totalizer is aluminum



# ENGINEERED TO ORDER

*with Off-the-Shelf Speed*

Instrumentation and control challenges are inevitable in the oil & gas, petrochemical and power industries. They can range from simple measurement applications to complex system integration issues. When you have a challenge, you can choose a solution potentially involving multiple companies and contractors, or SOR Controls Group can provide engineering expertise, custom designs, and produce a single solution tailored to your needs.

SOR Controls Group can customize nearly every product we offer, or design, develop and manufacture a custom product to meet your exact specifications. Our mixed-mode capabilities enable us to operate in a job shop environment with an OEM mentality.

We specialize in short-turn projects, but can also handle high-volume work.



Mini-Hermet Pressure Switch custom Pig Launcher on an export flow line for offshore oil production.

- SOR Controls Group has created over 3,500 unique product configurations to meet customer special requirements
- In the last 10 years, we have shipped more than 100,000 special Engineered to Order products
- Over 90,000 square feet of vertically integrated production capability located in Lenexa, Houston and Rochester
- Products are designed and manufactured to ISO 9001 Standards
- Management system is based on the principles of operational excellence and LEAN enterprise

## ENGINEERING EXPERTISE

SOR Controls Group is capable of offering fully integrated solutions from design to installation:

### ELECTRICAL/HARDWARE

- Advanced circuit design
- Designing for hazardous environments
- Testing for reliability, accuracy and safety

### FIRMWARE/SOFTWARE

- Firmware development
- Desktop/Application software development
- Industrial communication protocol experience

### MECHANICAL DESIGN

- Mechanical design development and prototyping tools
- Full drafting capabilities including 3-D modeling
- Finite element analysis (FEA)
- Research and Development: comprehensive testing and evaluation capabilities

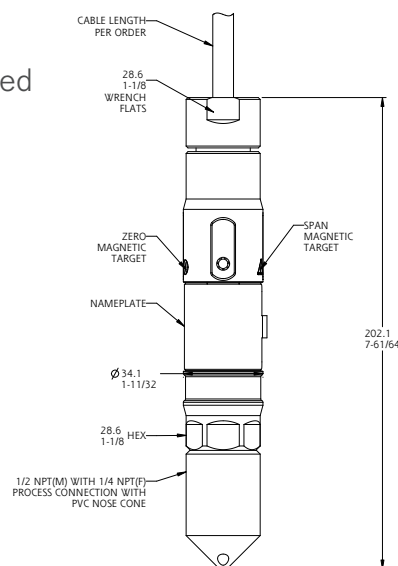

# MANUFACTURING CAPABILITIES

## MACHINING

- Precision machinists/tool & die makers
- CNC machining centers
- Full tool & die design, machining and fabrication

## WELDING & FABRICATION

- Certified MIG/TIG Welders
- Level II NDE/Certified Weld Inspector on staff
- ASME Section IX and AWS D2.1 qualified welding system
- Panasonic Perform Arc 122S robotic weld centers
- Capability to produce to ASME B31.1/B31.3 and PED 2014/68/EU

## ASSEMBLY, PAINT, TEST AND CALIBRATION

- Vertically integrated assembly, painting and test process capability
- Manufacturing and quality engineers dedicated to production operation



# Diaphragm Seals

SOR Diaphragm Seals are custom-manufactured to work on any high-performance chemical seal application such as high vacuum, high temperature, high sterility, custom design, high static pressure/low differential span or high vacuum/high temperature.



## THREADED SEALS

- Standard or large area (more sensitive) diaphragm with optional flushing port
- 30 inHg vac to 2500 psi
- Isolates sensor
- All 316SS
- Welded construction
- Custom assemblies & materials available



## FLANGED SEALS

- Standard or large area (more sensitive) diaphragm with optional flushing port
- Pipe sizes: 1, 1½, 2, 3, or 4"
- 30 inHg vac to 2500 psi
- Isolates sensor
- All 316SS
- Welded construction
- Custom assemblies & materials available



## SANITARY SEALS

- Tri-Clamp design for:  
¾, 1, 1½, 2, 2½, or 3" pipe
- 30 inHg vac to 600 psi
- Sanitary isolation of sensor
- Quick connecting tri-clamp
- Meets 3A sanitary standards





# Hazardous Area Classification

Hazardous Areas are locations where the potential for fire or explosion exists because of gases, dust or easily ignitable fibers in the atmosphere.

In North America, hazardous areas are separated by classes, divisions, and groups to define the level of safety required for equipment installed in these locations. Classes define the general form of the flammable materials in the atmosphere. Divisions define the probability of the presence of flammable materials. Groups classify the exact flammable nature of the material.



In Europe and countries outside of North America, classification of hazardous areas is accomplished differently. Zones are used to define the probability of presence of the flammable materials. Protection Types denote the level of safety for the device. Groups classify the exact flammable nature of the material. These groups are separated differently than North American Groups. Temperature Identifications convey the maximum surface temperature of the apparatus based on 104°F (40°C) ambient. These temperature codes are selected carefully so as not to exceed the ignition temperature of the specific gas or vapor to be encountered in the application.

# Environmental Protection

Similar to hazardous location classifications, environmental protection ratings are slightly different within and outside of North America. National Electrical Manufacturers Association (NEMA) and Ingress Protection (IP) Codes provide similar information regarding protection against specified environmental conditions.

- NEMA 4** Indoor or outdoor use. Protection against wind-blown dust and rain, splashing water, hose-directed water and damage from external ice formation.
- NEMA 4X** NEMA 4, plus protection against corrosion.
- IP 65** Dust-tight and protected against water jets.
- IP 68** Dust-tight and suitable for indefinite immersion.

Some classifications are not shown here. For further detailed information, see specific standards published by approval organizations.

# Certifications and Approvals

Each year, auditors visit SOR Controls Group. It's their objective to determine that our management systems conform with the audit criteria and it's effectiveness in achieving continuous improvement and system objectives. SOR Controls Group has maintained ISO 9001 certification every year since 1993. ISO certification ensures that we're doing things right while creating the highest quality products for our customers.















Additionally, many other products are approved for ordinary locations and hazardous locations. Various protection concepts used include Intrinsically Safe (IS) and Explosion Proof/Flameproof. SOR Controls Group offers Safety Integrity Level (SIL) certified products for its entire range of switches. SIL pressure and level switches are certified to the IEC 61508 safety standard.

We regularly undergo nuclear compliance audits by NUPIC, NIAC and TSSA.

## Agency Approvals

SOR Controls Group products satisfy the requirements of approval agencies worldwide. Often, a common design is capable of multiple approvals. In other cases, modified construction techniques are necessary to meet specific agency requirements.



	ATEX (BASEEFA, FM, SIRA)		INMETRO
	TestSafe (Australia)		Technology Institution of Industrial Safety
	Canadian Standards Association		Korean Occupational Safety and Health Agency
	CE Marked		SASO
CRN	CRN		Underwriters Laboratories
	Factory Mutual		IEC (International Electrotechnical Commission)
	Pressure Equipment Directive		Taiwan Safety
	SOR products are certified to IEC 61508 for non-redundant use in SIL1 and SIL2 Safety Instrumented Systems for most models. Heavy Industrial (Self-Certified)		UK Conformity Assessed

Design and specifications are subject to change without notice.  
For the latest revisions, visit [SORInc.com](http://SORInc.com).

# General Applications



## CHEMICAL/PETROCHEMICAL/REFINING

- Distillation Column
- Coker Unit
- Hydrodesulphurization (HDS) Unit
- Fluid Catalytic Cracking Unit (FCCU)
- Semi-Regenerative Catalytic Reformer Unit (SRRU)
- Hydrofluoric Acid Alkylation Unit (HFAU)
- Flare Knockout Drum
- Sump Level Control

## OIL & GAS

- Wellhead Control Panel (WHCP)
- Test Separator
- Casing & Tubing Pressure Monitoring
- Chemical Injection Skid
- Frac Sand Recovery Vessel
- Offshore Production Export Line
- Pipeline Flow Monitoring
- Tank Battery
- Residential Gas Utility
- Slug Catcher

## POWER GENERATION

- Boiler Feed Water
- Coal-Fired Power Plant
- Auxiliary Steam System
- Water Level Temperature Fluctuations
- Steam Turbine Drip Leg
- Hotwell Condenser
- Demineralization Unit
- Steam Drum Level
- Flue Gas Wet Scrubber
- Liquid Fuel Storage Vessel

## WATER & WASTEWATER

- Pump Over-Pressurization Protection
- Storm Water Level
- Flocculation Basin
- Primary Clarifier Level
- Secondary Treatment Bioreactor
- Biogas Pressure
- Sanitation System
- Septic Tank
- Sludge Air-Drying
- Osmotic Filter Integrity

## OTHER

- Pulp & Paper Plant
- Lube Oil System
- Cyclone Separator
- High Level Alarm Safety Shutoff



# STRATEGIC DIRECTION

**VISION** | We will be our customers' preferred partner for measurement and control.

**MISSION** | We leverage our ability and willingness to develop innovative engineered solutions from standard product platforms to create value for our customers.

**Who We Are** | We are a provider of niche measurement and control solutions to process industries. We compete on quality, reliability, delivery, high service levels to our customers and a willingness and ability to provide custom engineered solutions.

# STRATEGIC VALUES

**QUALITY** | We focus on the quality of our products  
We value the quality of our relationships with our customers, our representatives, and our associates  
We work to ensure the quality of data we share

**DELIVERY** | We protect the integrity of our lead times (On-time delivery)  
We work quickly and efficiently  
We act with a sense of urgency  
We are reliable  
We keep our promises

**CUSTOMER SERVICE** | We focus on helping the customer  
We go out of our way to help solve problems  
We are willing to do the right thing, even when it's the "hard" thing  
We make every customer feel like they are the only one we want



# 1800 Series PRESSURE TRANSMITTERS



SHORT LEAD TIMES



4-20 mA WITH OPTIONAL HART®, 1-5VDC  
LOW POWER OR MODBUS OUTPUT



±0.075% ACCURACY (F.S.)



ATEX/IECEX CERTIFIED FOR INTRINSICALLY  
SAFE AND FLAMEPROOF APPLICATIONS



CSA CERTIFIED FOR EXPLOSION  
PROOF APPLICATIONS



2, 3 AND 5-VALVE MANIFOLDS



3 YEAR WARRANTY

**1800DM**  
Differential Pressure with  
Direct Mount Diaphragm Seal



**1800PT**  
Conventional  
Gauge  
Pressure



**1800PR**  
Piezoresistive  
Gauge Pressure



**1800DP**  
Differential  
Pressure



**1800RM**  
Differential Pressure  
with Remote Mount  
Diaphragm Seals



## EASY | RUGGED | RELIABLE

### SALES OFFICES

**Beijing, China** | +86 10 5820 8767 | Fax +86 10 5820 8770

**Chennai, India** | +91 735 838 8250 | Fax +1 913-312-3572

**Dubai, UAE** | +971 4 278 9632 | Fax +1 913-312-3596

### Lenexa, KS, US

SOR Measurement and Control

+1 913-888-2630 | Fax +1 913-888-0767

### Houston, TX, US

SSi Temperature Sensors

+1 281-272-5333 | Fax +1 281-272-5332

SENSOR Sampling Systems

+1 281-902-3924 | Fax +1 281-272-5332

### Rochester, NY, US

PYRAGON Electronic Instrumentation

+1 585-697-0444 | Fax +1 585-697-0445

**SOR**  
CONTROLS GROUP